

Washington University in St. Louis

## Washington University Open Scholarship

---

All Theses and Dissertations (ETDs)

---

January 2009

### Regulation of BAX/BAK-Dependent Cell Death Program

Hyungjin Kim

*Washington University in St. Louis*

Follow this and additional works at: <https://openscholarship.wustl.edu/etd>

---

#### Recommended Citation

Kim, Hyungjin, "Regulation of BAX/BAK-Dependent Cell Death Program" (2009). *All Theses and Dissertations (ETDs)*. 428.

<https://openscholarship.wustl.edu/etd/428>

This Dissertation is brought to you for free and open access by Washington University Open Scholarship. It has been accepted for inclusion in All Theses and Dissertations (ETDs) by an authorized administrator of Washington University Open Scholarship. For more information, please contact [digital@wumail.wustl.edu](mailto:digital@wumail.wustl.edu).

WASHINGTON UNIVERSITY IN ST. LOUIS

Division of Biology and Biomedical Sciences

Program in Molecular Cell Biology

Dissertation Examination Committee:

Emily H.-Y. Cheng, Chair

Kendall J. Blumer

Phyllis I. Hanson

James J.-D. Hsieh

Paul Schlesinger

Jason D. Weber

REGULATION OF BAX/BAK-DEPENDENT CELL DEATH PROGRAM

by

Hyungjin Kim

A dissertation presented to the  
Graduate School of Arts and Sciences  
of Washington University in  
partial fulfillment of the  
requirements for the degree  
of Doctor of Philosophy

December 2009

Saint Louis, Missouri

copyright by

Hyungjin Kim

2009

## ABSTRACT

Mammals have evolved an intricate regulation of a genetically programmed apoptotic cell death that involves mitochondria. Diverse apoptotic signals converge on mitochondria, which causes the release of cytochrome *c* into the cytosol to activate Apaf-1. This initiates caspase activation, which results in irreversible cellular demise. The BCL-2 family proteins constitute a critical checkpoint in mitochondrion-dependent apoptosis. Multidomain proapoptotic BAX/BAK promotes mitochondrial outer membrane permeabilization, whereas anti-apoptotic BCL-2/BCL-X<sub>L</sub>/MCL-1 protects mitochondrial integrity and prevents cytochrome *c* release. The proapoptotic activity of BAX/BAK is triggered by BH3-only molecules (BH3s) which are upregulated by upstream death signals. However, how these subfamilies interact with one another to execute mitochondrial cell death remains unclear. Thus, this thesis aims at elucidating the mechanism regarding how the interplay between BCL-2 subfamilies determines cellular commitment to survival versus death and how BAX/BAK activation is triggered by BH3s.

Our laboratory showed that BH3s can be further classified into two subclasses- ‘activator’ tBID/BIM/PUMA that directly activates BAX/BAK to induce cytochrome *c* release and ‘inactivator’ BH3s that antagonize the function of anti-apoptotic BCL-2 members. Here, a BAX/BAK mutagenesis study indicated that anti-apoptotic BCL-2 members prevent BAX/BAK activation by sequestering activator BH3s rather than by directly binding to BAX/BAK. I further demonstrated that inactivator BH3s are able to displace activator BH3s from anti-apoptotic BCL-2 members with unique specificity, thus preventing their sequestration of activator BH3s. Activator BH3s were shown to act downstream of inactivator BH3s to trigger BAX/BAK activation, establishing the

hierarchy of BCL-2 subfamilies in regulating mitochondrial apoptosis. Then, I investigated the molecular mechanism whereby BAX/BAK is activated by activator BH3s. I demonstrated that BAX undergoes stepwise structural reorganization leading to two activation processes-mitochondrial targeting and homo-oligomerization. Activator BH3s initiate BAX activation by attacking and exposing  $\alpha 1$  helix of BAX leading to the secondary disengagement of the  $\alpha 9$  helix and mitochondrial translocation. Activator BH3s remain associated with BAX to drive homo-oligomerization at the mitochondria. BAK has bypassed the first activation step, but requires activator BH3s for homo-oligomerization. This study further emphasizes the direct engagement of activator BH3s in BAX/BAK-dependent mitochondrial apoptotic pathway. Lastly, our laboratory showed that BH3s trigger caspase-independent mitochondrial dysfunction only in the presence of BAX/BAK. I found that BAK exists as several distinct complexes at the mitochondria, one of which is functionally different from cytochrome *c*-releasing BAK oligomers but instead includes VDAC/ANT channels that regulate ATP/ADP transport to support ATP production by oxidative phosphorylation. tBID overexpression induces cell death in the absence of Apaf-1 by inhibiting VDAC-mediated ADP import into the mitochondria in a BAK-dependent manner, suggesting that activated BAK antagonizes VDAC activity to initiate mitochondrial dysfunction. This study provides novel insights into how BAK activation couples apoptosis and mitochondrial dysfunction to trigger cell death.

## ACKNOWLEDGEMENTS

First and foremost, I would like to give my deepest thanks to my mentor, Dr. Emily Cheng, for her commitment to train and support me throughout the study. Her excellent guidance and genuine passion for research inspire me to keep doing science at the highest level everyday.

I am greatly indebted to many great scientists around me. I would like to thank my committee: Drs. Kendall Blumer, Phyllis Hanson, James Hsieh, Paul Schlesinger, and Jason Weber, whose wonderful advice and insightful criticism are deeply appreciated. I would like give special thanks to Dr. James Hsieh for his guidance on both science and life, and Dr. Paul Schlesinger for sharing his expertise on VDAC channels. I would also like to thank Drs. Naohiro Inohara, Eugene Johnson, and Hisashi Harada for generously providing *Hrk*, *Dp5*, and *Bim* knockdown constructs, Drs. John Jeffers and Gerald Zambetti for providing *Puma*<sup>-/-</sup> MEFs, and Dr. Richard Youle for providing 6A7 antibody. I have furthermore to thank Dr. Jeongbin Yim at Seoul National University for giving me the opportunity to start a career in biology.

I feel absolutely lucky to have had great and talented people in the lab. Mubina Rafiuddin-Shah conducted cell viability assays which are integral parts of chapter 2, and Dr. Decheng Ren generated SV40-transformed *Bim/Puma* DKO MEFs used in chapter 3. Ho-Chou Tu established a tBID-inducible *Apaf-1* knockout cell system used in chapter 4. I also thank Hsiu-Fang Chen for excellent technical assistance and lab management, Gary Wang and Greg Bean for critically reading the manuscript. I give special thanks to Ho-Chou Tu, David Chen, and Shugaku Takeda with whom I have spent all my graduate life from the beginning.

I am grateful that I have wonderful friends around at Washington University who have made my life in St. Louis full of memory in particular Soomin Shim, Jae-Eun Kang, Kyusang Jung, Seol-Hee Im, Won-Jae Huh, and Joohyun Lim. I would also like to thank my family including my parents and parents-in law for their encouragement and support.

Lastly, this work is dedicated to my wife, Yoojung, who always encourages me with everlasting love and support. She has constantly taught me that I can be better today than yesterday. Without her, I could not be what I am today.

## TABLE OF CONTENTS

<b>Abstract</b> .....	ii
<b>Acknowledgements</b> .....	iv
<b>Table of Contents</b> .....	vi
<b>List of Figures and Tables</b> .....	ix
<b>Chapter 1: Introduction</b> .....	1
1.1. Mammalian apoptosis.....	2
1.2. BCL-2 family members.....	3
1.3. Genetic knockout models of the BCL-2 family.....	6
1.4. Regulation of BAX/BAK activation.....	8
1.5. Interplay of BCL-2 family members for survival/death decision.....	12
1.6. The BCL-2 family as a regulator of mitochondrial physiology.....	15
1.7. Significance.....	17
1.8. Figure legends.....	19
1.9. Figures.....	20
<b>Chapter 2: Hierarchical regulation of mitochondrion-dependent apoptosis by BCL-2 subfamilies</b> .....	23
2.1. Summary.....	24
2.2. Introduction.....	25
2.3. Materials and methods.....	28
2.4. Results.....	32



2.5. Discussion.....	41
2.6. Figure and table legends.....	45
2.7. Figures and tables.....	55
<b>Chapter 3: Stepwise activation of BAX/BAK by tBID, BIM, and PUMA initiates mitochondrial apoptosis.....</b>	<b>76</b>
3.1. Summary.....	77
3.2. Introduction.....	78
3.3. Materials and methods.....	82
3.4. Results.....	85
3.5. Discussion.....	96
3.6. Figure and table legends.....	100
3.7. Figures and tables.....	112
<b>Chapter 4: BAK triggers mitochondrial dysfunction by inhibiting VDAC activity upon activation by BH3-only molecules.....</b>	<b>136</b>
4.1. Summary.....	137
4.2. Introduction.....	138
4.3. Materials and methods.....	143
4.4. Results.....	148
4.5. Discussion.....	154
4.6. Figure legends.....	158
4.7. Figures .....	164

<b>Chapter 5: Conclusion and Future Directions</b> .....	175
5.1. Conclusion.....	176
5.2. Future directions.....	179
<b>References</b> .....	189
<b>Curriculum Vitae</b> .....	207

## LIST OF FIGURES AND TABLES

### CHAPTER 1

Figure 1.1	Schematic summary of three BCL-2 subfamily members.....	20
Figure 1.2	NMR Structure comparisons of BAX monomer and BCL-X <sub>L</sub> /BAK BH3 peptide complex.....	21
Figure 1.3	Schematic model of pro-apoptotic activation cascade.....	22

### CHAPTER 2

Figure 2.1	BID, BIM and PUMA directly activate BAX and BAK to induce cytochrome <i>c</i> release from mitochondria.....	55
Figure 2.2	BAK is kept in check by VDAC2 but not by BCL-X <sub>L</sub> or MCL-1.....	58
Figure 2.3	BAK is not kept in check by BCL-X <sub>L</sub> or MCL-1.....	60
Figure 2.4	Anti-apoptotic BCL-2 proteins inhibit apoptosis by sequester activator BH3-only molecules, preventing them from activating BAX/BAK.....	62
Figure 2.5	Activator BH3-only molecules sequestered by anti-apoptotic BCL-2 members can be displaced by inactivator BH3-only molecules to activate BAX/BAK-dependent mitochondrial apoptosis.....	65
Figure 2.6	BAD and NOXA synergize to trigger apoptosis by displacing BIM and PUMA from anti-apoptotic BCL-2 members to activate BAX and BAK.....	68
Figure 2.7	Schematic representation of the mammalian core apoptotic pathways.....	69
Figure 2.8	The anti-apoptotic activity of BCL-2, BCL-X <sub>L</sub> and MCL-1 against various death stimuli is differentially regulated by specific inactivator BH3-only molecules.....	70

Table 2.1	Summary of differential regulation of the anti-apoptotic activity of BCL-2, BCL-X <sub>L</sub> or MCL-1 against activator BH3s by various inactivator BH3s.....	71
-----------	---	----

### Supplementary figures

Figure S2.1	Expression level of BH3-only molecules.....	72
Figure S2.2	Co-immunoprecipitation of BAX/BAK mutants.....	73
Figure S2.3	Cell viability of various MEFs.....	74
Figure S2.4	BCL-2 family expression and interactions.....	75

### CHAPTER 3

Figure 3.1	Mitochondrial targeting and homo-oligomerization are two separable, essential steps of BAX activation.....	112
Figure 3.2	Characterization of homo-oligomerization and mitochondrial targeting of BAX.....	115
Figure 3.3	BH1 and BH3 domains of BAX are required for its activation.....	117
Figure 3.4	Activation of BAX can be dissected into two sequential steps, mitochondrial targeting and homo-oligomerization, both of which require activator BH3s.....	119
Figure 3.5	BH1 and BH3 domains are required for the homo-oligomerization and proapoptotic activity of BAK.....	122
Figure 3.6	BIM and PUMA activate mitochondrial BAK and BAX to execute apoptosis upon ER stress.....	125

Figure 3.7 Schematic depicts the model for activation of BAX and BAK driven by “activator” BH3s.....	127
Table 3.1 Summary of BAX and BAK mutants.....	128

### Supplementary figures

Figure S3.1 Reconstitution of BAX or BAK mutants to <i>Bax/Bak</i> DKO MEFs.....	129
Figure S3.2 <i>Bax</i> -deficient MEFs display faster death kinetics in comparison with <i>Bak</i> -deficient MEFs.....	130
Figure S3.3 BH1 and BH3 domain mutants of BAX fail to form homo-dimers.....	131
Figure S3.4 BAX P168A fails to expose its N-terminus upon DNA damage.....	131
Figure S3.5 NP-40 disrupts the binding of the $\alpha 1$ helix of BAX to BAX $\Delta$ N.....	131
Figure S3.6 tBID, but not BAD or BMF binds to the $\alpha 1$ helix of BAX.....	132
Figure S3.7 tBID, but not BMF induces the N-terminal exposure of BAX and remains associated with the N-terminally exposed BAX.....	132
Figure S3.8 Figure S3.8. tBID, but not BMF induces the homo-oligomerization of BAX S184V.....	133
Figure S3.9 BH1 domain is required for N-terminally exposed BAX to interact with tBID.....	133
Figure S3.10 YFP-BAK $\Delta$ C/Cb5 TM colocalizes with DsRed-ER whereas YFP-BAK $\Delta$ C/OMP25 TM colocalizes with DsRed-Mito.....	134
Figure S3.11 BCL-2 does not homo-oligomerize in response to tBID.....	135

## CHAPTER 4

Figure 4.1 BAK associates with the VDAC/ANT complex that can be extracted by high concentration of CHAPS detergent.....	164
Figure 4.2 BAK constitutes functionally distinct complexes at the mitochondria.....	165
Figure 4.3 BAK is required for shutting down VDAC activity upon activation by BH3s.....	169
Figure 4.4 tBID is recruited to the VDAC/ANT complex, but requires BAK to kill cells.....	172
Figure 4.5 Schematic depicts the dual role of BAK in mediating both cytochrome <i>c</i> dependent caspase activation and mitochondrial dysfunction.....	174

**- CHAPTER 1 -**

**Introduction**

## **1.1. Mammalian apoptosis**

Apoptosis, the best characterized type of programmed cell death, is an orchestrated event of genetic and biochemical pathways that is conserved in all multicellular organisms (Danial and Korsmeyer, 2004; Horvitz, 2003). This tightly regulated process was initially characterized by cell shrinkage, membrane blebbing, chromatin condensation, and DNA fragmentation (Kerr et al., 1972; Wyllie et al., 1980). Proper execution of apoptosis is crucial for normal embryonic development and adult tissue homeostasis. In this respect, deregulation of the core apoptotic pathway often results in unbalanced cellular status that causes human diseases (Thompson, 1995). For instance, insufficient elimination of aberrant cells can lead to cancer and autoimmunity whereas accelerated apoptosis can elicit neurodegenerative disorders.

The execution of apoptosis is mediated by the activation of a family of cysteine proteases known as caspases. Caspases exist as zymogens in viable cells, but once activated, they cleave diverse intracellular substrates resulting in breakdown of the cell accompanied by characteristic morphological changes (Thornberry and Lazebnik, 1998). Two major cell death pathways exist to trigger caspase activation in mammalian cells. The extrinsic pathway operates downstream of transmembrane death receptors such as TNFR1 (tumor necrosis factor receptor 1), Fas (APO1/CD95), and TRAILR1/2 (TNF-related apoptosis-inducing ligand receptor 1/2) activated by the engagement of their death ligands from outside the cell (Danial and Korsmeyer, 2004). Activated receptors form a death-inducing signaling complex (DISC) that leads to the activation of initiator caspase-8 and -10, which directly cleave and activate effector caspase-3 and -7. The intrinsic pathway is initiated by a variety of cellular stress including cytokine/growth factor



deprivation, genotoxic or endoplasmic reticulum (ER) stress, and involves mitochondria as a death checkpoint. The intrinsic cell death signals culminate in the permeabilization of the mitochondrial outer membrane, which triggers cytochrome *c* release into the cytosol (Thornberry and Lazebnik, 1998; Wang, 2001). Cytosolic cytochrome *c* binds to Apaf-1, an apaptor protein that exists as an inactive monomer in the cytosol, and initiates the conformational change that leads to the oligomerization of Apaf-1 into a heptameric protein complex called the apoptosome, which recruits and activates initiator caspase-9 (Shi, 2006). Activated caspase-9 subsequently cleaves and activates effector caspases such as caspase-3 and -7. In addition to cytochrome *c*, apoptogenic factors including Smac/DIABLO, EndoG, HtrA2/Omi, and AIF are released from the mitochondria and further facilitate to cellular demise (Du et al., 2000; Li et al., 2001; Susin et al., 1999; Van Loo et al., 2001; Verhagen et al., 2000). In some cell types such as lymphocytes (type I cells), the signaling from the extrinsic pathway is sufficient to engage apoptosis, whereas amplification of the apoptotic signaling through the intrinsic pathway is required for the cell death of hepatocytes and pancreatic  $\beta$ -cells (Type II cells).

## **1.2. BCL-2 family members**

The BCL-2 family members are core regulatory proteins that control the permeabilization of the mitochondrial outer membrane in the intrinsic cell death pathway. The *BCL-2* gene was first cloned in the t(14;18) chromosomal translocation breakpoints of B-cell follicular lymphomas (Bakhshi et al., 1985; Cleary et al., 1986; Tsujimoto et al., 1985). Subsequently, BCL-2 overexpression was shown to inhibit cell death against various cellular insults and confer oncogenic potential; as such, *BCL-2* is recognized as a

new class of oncogene that contributes to tumor development by protecting cells from apoptosis rather than by increasing cellular proliferation (McDonnell et al., 1989; Vaux et al., 1998). The number of BCL-2 family members has exploded ever since with members falling into one of three subfamilies based on the presence of up to four conserved regions termed *BCL-2 Homology* (BH) domains and on their death regulatory activities (Cory and Adams, 2002; Danial and Korsmeyer, 2004; Gross et al., 1999) (Fig. 1.1). The anti-apoptotic members, including BCL-2, BCL-X<sub>L</sub>, BCL-W, MCL-1, and A1, share sequence homology through all four BH domains and safeguard mitochondria outer membrane integrity. The prosurvival function of BCL-2 is also conserved in the *C. elegans* orthologue CED-9 (Hengartner et al., 1992). The other two subfamilies promote apoptosis. The multidomain proapoptotic BAX and BAK share BH1-3 domains and promote cell death by inducing the release of cytochrome *c* and other apoptogenic factors from mitochondria. The members of the third subfamily are termed BH3-only molecules (BH3s) in that they only exhibit sequence homology within this domain (Kelekar and Thompson, 1998; Gross et al., 1999). Such members including BID, BIM, PUMA, BAD, NOXA, BMF, BIK/BLK, and HRK/DP5 act as proapoptotic sentinels to convey upstream stress signals to the terminal multidomain BCL-2 family members at the level of mitochondria by either activating BAX/BAK or inactivating anti-apoptotic BCL-2 members.

Since distinct BH3s initiate programmed cell death in different types of cells in response to diverse stress conditions, their prodeath activity is placed under stringent control. On the one hand, specific stresses lead to the transcriptional upregulation of specific BH3s. For instance, PUMA and NOXA is transcriptionally upregulated as direct

targets of p53 in response to genotoxic stress (Nakano and Vousden, 2001; Oda et al., 2000; Yu et al., 2001). The expression level of HRK/DP5 is upregulated following NGF withdrawal or A $\beta$  treatment in cultured neurons (Imaizumi et al., 1997). Growth factor withdrawal induces the upregulation of BIM expression, which requires JNK activation in neurons and forkhead transcription factor FKHR-L1 in hematopoietic cells (Dijkers et al., 2000; Putcha et al., 2001; Whitfield et al., 2001). On the other hand, some of the BH3s are easily detectable in healthy cells, and their proapoptotic activity is unleashed by post-translational modifications. BAD undergoes dephosphorylation upon growth factor deprivation, allowing its dissociation from the 14-3-3 scaffolding protein and thereby its interaction with BCL-X<sub>L</sub> (Zha et al., 1996). Inactive BID is proteolytically cleaved by caspase-8 and N-myristoylated, which promotes efficient mitochondrial targeting and increased affinity to multidomain BCL-2 members (Zha et al., 2000). BMF is regulated by the interaction with DLC2 dynein light chains sequestering it to the actin-bound myosin V motor complex (Puthalakath et al., 2001). Activation of BIM-L and -EL isoforms by UV-irradiation or taxol treatment involves their release from the dynein motor complex, and loss of the ERK-mediated phosphorylation of BIM-EL prevents it from being degraded by ubiquitin-proteasome system (Ley et al., 2005; Puthalakath et al., 1999). It was also demonstrated that ER stress causes the direct induction of *Bim* transcript by CHOP-C/EBP $\alpha$  and the stabilization of BIM-EL through protein phosphatase 2A-mediated dephosphorylation (Puthalakath et al., 2007).

### 1.3. Genetic knockout models of the BCL-2 family

Mouse knockout studies have not only highlighted the importance of BCL-2 family members in regulating apoptosis for successful embryogenesis and tissue homeostasis, but also revealed their specific involvements in different signaling pathways and cell types. Mice with single knockout of *Bax* or *Bak* reveal functional redundancy such that *Bak* deficiency alone has no obvious phenotype, and *Bax*-deficient mice behave normally with limited phenotypic abnormalities such as male sterility. On the other hand, the majority of mice lacking both genes die perinatally, and the fewer than 10 % that survive into adulthood show various developmental abnormalities in the digits, female reproductive tract, and the central nervous system, as well as increased numbers of hematopoietic precursors and mature lymphocytes (Lindsten et al., 2000). Also, *Bax/Bak* DKO mouse embryonic fibroblasts (MEFs) are completely resistant to caspase-dependent apoptosis triggered by all of the tested intrinsic death signals as well as overexpression of BH3s, suggesting that BAX and BAK constitute an essential gateway in regulating intrinsic cell death pathway downstream of the BH3-only subfamily (Cheng et al., 2001; Wei et al., 2001; Zong et al., 2001). In addition, a study using *Bax/Bak* DKO MEFs defined BAX and BAK as a critical cell death gateway at the ER against apoptotic signals that affect  $\text{Ca}^{2+}$  release from the ER (Scorrano et al., 2003).

The BH3-only family member BIM was shown to be essential for developmentally programmed apoptosis of thymocytes in mammals. *Bim*-deficient mice show abnormal accumulation of lymphoid and myeloid cells, and lymphocytes are resistant to cytokine deprivation and calcium ion flux, emphasizing a critical role for BIM in the hematopoietic system (Bouillet et al., 1999). Importantly, loss of a single allele of

*Bim* prevents the fatal polycystic kidney disease and lymphopenia of *Bcl-2*<sup>-/-</sup> mice, suggesting that BIM acts downstream of BCL-2 in the same apoptosis-regulatory pathway (Bouillet et al., 2001). *Bid*<sup>-/-</sup> mice are resistant to Fas-induced hepatocyte apoptosis and fatal hepatitis (Yin et al., 1999). Cells derived from *Puma*<sup>-/-</sup> mice are profoundly resistant to DNA damage, cytokine deprivation, glucocorticoid, and phorbol ester (Jeffers et al., 2003; Villunger et al., 2003). In contrast, knockout mice deficient for other BH3s exhibit only mild phenotypic abnormalities. Interestingly, BH3-only double knockout (DKO) mice reveal additional defects that are not observed in single knockout mice. For example, while loss of PUMA alone does not cause any obvious defect in lymphocyte development, *Bim/Puma* DKO mice exhibit hyperplasia of lymphatic organs exceeding the hyperplasia observed in *Bim*<sup>-/-</sup> mice (Erlacher et al., 2006). Moreover, the combined loss of BIM and PUMA promotes spontaneous tumorigenesis, causing the similar malignancies observed in the *Bcl-2* transgenic mice (Erlacher et al., 2006). On the other hand, it was reported that *Bid/Bim* DKO mice mostly resemble single knockout mice (Willis et al., 2007). These results imply that generation of mice with more than two BH3-only knockouts is necessary to uncover additional compound phenotypes.

Knockouts of the anti-apoptotic BCL-2 members validate their important prosurvival function in specific tissues or cell types, reflecting their unique expression patterns. *Bcl-2*<sup>-/-</sup> mice are normal at birth but exhibit severe defects with age in their immune system, hair follicles, and renal epithelial cells ultimately developing polycystic kidney disease (Veis et al., 1993). *Bcl-x*<sup>-/-</sup> mice survive only until E13.5 due to severe apoptosis of neuronal and hematopoietic cells (Motoyama et al., 1995). Also, genome-wide *N*-ethyl-*N*-nitrosourea (ENU) mutagenesis of mice identified the mutations in BCL-

$X_L$  that limit the life span of platelets, and accordingly, *Bcl-x<sub>L</sub>* heterozygous knockout mice exhibit thrombocytopenia (Mason et al., 2007). *Mcl-1<sup>-/-</sup>* mice show perimplantation embryonic lethality, and conditional knockout reveals the importance of MCL-1 in maintaining the survival and development of hematopoietic stem cells, thymocytes, and B lymphocytes (Opferman et al., 2003; Opferman et al., 2005; Rinckenberger et al., 2000).

#### **1.4. Regulation of BAX/BAK activation**

While proapoptotic multidomain BAX and BAK are essential downstream effectors, they need to be activated by BH3s to homo-oligomerize and mediate cytochrome *c* release. Since BAX and BAK are abundantly expressed in healthy cells, their activity must be tightly kept in check (Cheng et al., 2001; Lindsten et al., 2000; Wei et al., 2001). Both BAX and BAK contain a C-terminal hydrophobic transmembrane domain, which is utilized by other BCL-2 family members for mitochondria targeting (Nguyen et al., 1993). Indeed, BAK is an integral membrane protein that is tail-anchored at the mitochondrial outer membrane. Genetic and biochemical analyses identified the mitochondria outer membrane protein voltage-dependent anion channel 2 (VDAC2) to be responsible for BAK inhibition (Cheng et al., 2003). BAK, but not BAX, interacts with the mammalian-restricted VDAC2 isoform, but not with the more abundant VDAC1. VDAC2 prevents BAK self-oligomerization by directly binding to the dimerization pocket of BAK. Therefore, VDAC2 specifically inhibits BAK-dependent mitochondrial apoptosis. Importantly, genetic deletion of *Vdac2* in the thymus results in excessive cell death with hypersensitivity to diverse death stimuli, which is completely rescued by the

concurrent deletion of *Bak*, but not *Bax*, emphasizing the role of the VDAC2-BAK axis in regulating thymocytes homeostasis (Ren et al., 2009).

On the other hand, BAX mainly resides in the cytosol as an inactive monomer, and during the early stage of apoptosis, it translocates from the cytosol to mitochondria (Hsu and Youle, 1997; Wolter et al., 1997). The solution structure of human BAX was determined by NMR (nuclear magnetic resonance) spectroscopy (Suzuki et al., 2000) (Fig. 1.2A). The resolved three-dimensional structure indicated that BAX adopts an auto-inhibited conformation such that the C-terminal transmembrane  $\alpha 9$  helix is folded back into the hydrophobic dimerization pocket composed of BH1, BH2, and BH3 domains; therefore the contacts between the  $\alpha 9$  helix and the BH3 binding pocket prevents dimer formation and mitochondrial targeting (Suzuki et al., 2000). This implies that an energy-driven conformational change may be required to free the  $\alpha 9$  helix from the dimerization pocket. Furthermore, it is conceivable that the auto-inhibited conformation of BAX is stabilized by its associated protein. Indeed, several cytosolic retention factors of BAX have been reported to modulate BAX activation. These include cytosolic Ku70, a small peptide humanin, 14-3-3 isoforms ( $\sigma$ ,  $\theta$ ,  $\epsilon$ , and  $\zeta$ ),  $\alpha A$ - and  $\alpha B$ -crystallin, and the apoptosis repressor with caspase-recruitment domain (ARC) (Guo et al., 2003; Gustafsson et al., 2004; Mao et al., 2004; Nam et al., 2004; Nomura et al., 2003; Samuel et al., 2001; Sawada et al., 2003). However, these identified BAX inhibitors do not appear to provide a universal mechanism to control BAX activation, and their significance in regulating BAX activation is not convincing.

How BAX/BAK is activated upon the presence of death stimuli is not fully understood. It is known, however, that BH3s induce conformational changes and homo-

oligomerization of BAX/BAK (Korsmeyer, 2000; Reed, 2006). For instance, tBID was shown to induce conformational change of BAX to trigger mitochondrial translocation and homo-oligomerization of BAX at the mitochondrial outer membrane (Desagher et al., 1999; Eskes et al., 2000). tBID was also able to disrupt the BAK-VDAC2 complex to release BAK allowing its homo-oligomerization and subsequent cytochrome *c* release (Cheng et al., 2003; Wei et al., 2000).

The monoclonal BAX 6A7 antibody is commonly used to identify the rearrangement of BAX conformation since its epitope, N-terminal amino acids 12-24, is inaccessible when BAX is in its inactive conformation but becomes exposed during BAX activation (Desagher et al., 1999; Hsu and Youle, 1998; Nechushtan et al., 1999). Crystallization of the complex between 6A7 antibody and the epitope peptide suggests that a significant remodeling of the BAX N-terminal region is required during apoptosis (Peyerl, 2006). Consequently, N-terminal exposure of BAX has been routinely used as a marker for BAX activation, but its correlation with mitochondria translocation and homo-oligomerization remains obscure. For instance, some studies have suggested that N-terminal exposure can be reversible in the presence of lipid and is insufficient for commitment to apoptosis (Makin et al., 2001; Yethon et al., 2003).

Several lines of evidence indicate that major conformational changes in the N-terminal and C-terminal regions are important for initiating BAX activation and targeting to mitochondria (Lalier et al., 2007). An N-terminal region of 19 amino acids named ART (apoptosis-regulating targeting domain) was shown to repress BAX targeting to the mitochondria, and ART-deleted BAX caused enhanced cytotoxicity after transfection (Goping et al., 1998). The hydroxyl group of Ser<sup>184</sup> in the  $\alpha 9$  helix forms a hydrogen



bond with the carboxyl group of Asp<sup>98</sup> in the  $\alpha 4$  helix, and S184V/ $\Delta$ S184 mutation in the C-terminal  $\alpha 9$  helix causes BAX to localize at the mitochondria in healthy cells (Nechushtan et al., 1999; Suzuki et al., 2000). C-terminal deletion of BAX results in the exposure of N-terminus, implying that N- and C- termini may be functionally connected to regulate BAX function (Nechushtan et al., 1999). Also, mutagenesis of amino acids located upstream of the  $\alpha 9$  transmembrane region revealed that Pro<sup>168</sup> regulates N-terminal exposure and the release of the C-terminal region (Schinzel et al., 2004). Interestingly, the  $\alpha 1$  helix of BAX was shown to interact with BID and PUMA, and the inhibition of the physical interaction between them could prevent BAX activation (Cartron et al., 2004). In addition, our recent structural analysis defined the  $\alpha 1$  and  $\alpha 6$  helices with an interhelical junction as the binding site for BIM BH3 peptide to trigger BAX activation, which is located opposite to the conventional hydrophobic pocket (Gavathiotis et al., 2008). These studies suggest that interaction of BH3s with the N-terminus of BAX may contribute to initiating the conformational change of BAX.

The other critical step for BAX/BAK activation is homo-oligomerization at the mitochondria during apoptosis, which is responsible for the permeabilization of mitochondrial outer membrane to release apoptogenic factors. Enforced dimerization of FKBP (FK506 binding protein)-BAX induced by the FK1012 ligand targeted BAX chimera to mitochondria and induced apoptosis (Gross et al., 1998). Upon treatment with tBID, BAX was shown to form a higher-ordered oligomeric complex at the mitochondria that was captured by chemical cross-linkers (Eskes et al., 2000). Gel filtration analysis of BAX from isolated mitochondria after death stimuli also demonstrated the appearance of large molecular weight oligomers/complexes (Antonsson et al., 2001). A study using

recombinant BAX in the liposome indicate that it can form  $\sim 22$  Å tetrameric pores that are capable of mediating the initial efflux of cytochrome *c* (Saito et al., 2000). It also highlights the importance of tetramers rather than dimers in permeabilizing membranes. Furthermore, tBID- or detergent-activated BAX was sufficient to produce supramolecular openings in the liposome that could allow the translocation of large molecules (Kuwana et al., 2002). tBID induces a distinct conformational change of BAK that is revealed by an altered pattern of trypsin-digested BAK and by the formation of higher-ordered BAK oligomers in the mitochondrial membrane (Cheng et al., 2003; Wei et al., 2000). During BAK activation, BAK was shown to expose its BH3 domain to form homo-dimers through BH3:groove interactions, which would nucleate the formation of BAK oligomers (Dewson et al., 2008). However, the precise molecular mechanisms by which BAX/BAK is activated by BH3s remain largely unknown.

### **1.5. Interplay of BCL-2 family members for survival/death decision**

Homo-dimerization and hetero-dimerization are one of the signature characteristics of BCL-2 family proteins. These interactions are known to determine the prodeath or prosurvival activity of BCL-2 subfamily members. The conserved BH domains drive interactions among various BCL-2 members. Three-dimensional structure of BCL-X<sub>L</sub> and a peptide spanning the BH3 domain of BAK revealed that the amphipathic helix of the BAK BH3 motif containing a leucine and three conserved hydrophobic residues occupies the hydrophobic pocket made from the BH1, BH2, and BH3 domains of BCL-X<sub>L</sub> (Sattler et al., 1997) (Fig. 1.2B). Subsequent structural studies of BCL-X<sub>L</sub>/BAD and BCL-X<sub>L</sub>/BIM further supported the general mode of interaction

between the  $\alpha$ -helical BH3 domain and the hydrophobic pocket (Liu et al., 2003; Petros et al., 2000).

Among BH3s, murine *Bid* was first cloned by its ability to interact with BAX and BCL-2 during protein interactive cloning; it was further demonstrated that the intact BH3 domain of BID is required for it to bind to the BH1 domain of BCL-2 and BAX (Wang et al., 1996). The overall three-dimensional structure of BID that contains two central hydrophobic core helices resembles the pore-forming domains found in BCL-X<sub>L</sub> and the bacterial pore-forming toxins of diphtheria toxin fragment B and colicin, raising the possibility that the activated form of BID may permeabilize the mitochondrial outer membrane by itself (Chou et al., 1999; McDonnell et al., 1999). However, BAX and BAK were proven to be required for BID-induced cytochrome *c* release since the activated form of BID, tBID (truncated BID; p15 BID) could not trigger cytochrome *c* release in the absence of BAX/BAK, nor could it alone permeabilize liposomes (Kuwana et al., 2002; Wei et al., 2000; Wei et al., 2001). Therefore, tBID functions as a membrane targeting death ligand that regulates the activity of the death receptor BAK rather than as a direct pore-forming protein responsible for cytochrome *c* release (Korsmeyer, 2000) (Fig. 1.3).

In contrast, the most critical function of anti-apoptotic BCL-2 members is to be the binding and sequestration of BH3s. Overexpression of anti-apoptotic BCL-2 or BCL-X<sub>L</sub> could sequester tBID into stable mitochondrial complexes, thus preventing BAX/BAK activation (Cheng et al., 2001). Seminal structural and biochemical studies revealed that BH3s display binding specificities with selected multidomain BCL-2 members (L. O'Connor, 1998; Oda et al., 2000; Wang et al., 1996; Yang et al., 1995).

Based on these observations, it was proposed that BH3s can either activate BAX/BAK or inactivate BCL-2/BCL-X<sub>L</sub>/MCL-1 according to their selective interactions to promote apoptosis (Kelekar and Thompson, 1998). This “two-class” model of BH3s was experimentally validated using BH3 domain peptides derived from various BH3s. The peptides derived from the  $\alpha$ -helical BH3 domains of BID and BIM directly trigger BAX/BAK oligomerization causing mitochondria outer membrane permeabilization, thus BID and BIM are termed ‘activator’ BH3s (Letai et al., 2002). BAD- and NOXA-BH3 peptides, on the other hand, induce BAX/BAK activation indirectly by serving as ‘sensitizer’ BH3s that antagonize the ability of anti-apoptotic BCL-2 members to sequester tBID (Letai et al., 2002). Interestingly, anti-apoptotic BCL-2, BCL-X<sub>L</sub>, and MCL-1 are selectively antagonized by a different subset of BH3s since they do not interact equivalently with sensitizer BH3s. For instance, BAD-BH3 peptides show selective binding affinity to BCL-2, BCL-X<sub>L</sub>, and BCL-W, while MCL-1 and A1 are primarily occupied by NOXA-BH3 peptides (Chen et al., 2005; Kuwana et al., 2005; Letai et al., 2002). However, these peptide binding studies have limitations in that the 25-26 amino acid fragments of the BH3 peptide may not fully recapitulate the regulatory function of full-length proteins. Furthermore, such dual classification has not been validated *in vivo*.

The interaction between activator BH3s and BAX has been demonstrated by various methodologies such as bacterial two-hybrid, immunoprecipitation, and biochemical studies (Cartron et al., 2004; Harada et al., 2004; Marani et al., 2002). However, low binding affinity between activator BH3s and BAX casts doubt on the existence of activator BH3-driven BAX/BAK activation. Instead, an alternative model

proposes that BAX and BAK are constantly kept in check by interacting with anti-apoptotic BCL-2 members, and that the disruption of the interaction between BAX/BAK and anti-apoptotic BCL-2 members by BH3s is necessary and sufficient to trigger BAX/BAK activation (Adams and Cory, 2007). In this model, activation of BAX/BAK occurs by default as long as BAX/BAK is no longer inhibited by anti-apoptotic BCL-2 members (Chen et al., 2005; Willis et al., 2005; Willis et al., 2007).

However, further evidence of activator BH3-mediated BAX activation was shown by a synthetic liposome system where the combination of recombinant tBID or BID/BIM BH3 domain peptides and BAX protein is sufficient to induce BAX oligomerization and membrane permeabilization (Kuwana et al., 2002; Kuwana et al., 2005; Walensky et al., 2006). In addition, the strategy of employing hydrocarbon-stapled BH3 peptides to increase the  $\alpha$ -helicity and stability of the short BH3 motif enhances the binding affinity between BAX and the BID/BIM BH3 domains (Walensky et al., 2004; Walensky et al., 2006). Furthermore, FRET (fluorescence resonance energy transfer) analysis of the liposome system allowed for the observation of an ordered series of tBID-induced BAX activation and membrane permeabilization, as well as displacement of tBID from BCL-X<sub>L</sub> by BAD (Lovell et al., 2008). Taken together, these studies clearly support the direct activation model where activator BH3s directly engage BAX/BAK to trigger BAX/BAK-dependent mitochondrial apoptosis.

### **1.6. The BCL-2 family as a regulator of mitochondrial physiology**

The mitochondrion serves as a powerhouse of cells by generating cellular ATP through oxidative phosphorylation coupled with electron transport (Newmeyer and

Ferguson-Miller, 2003). Therefore, in addition to the release of apoptogenic factors by mitochondrial outer membrane permeabilization, the regulation of mitochondrial physiology is also an important control point for cell death. The voltage-dependent anion channel (VDAC) is responsible for the exchange of cytosolic ADP and mitochondrial ATP, and it also facilitates the passage of other metabolic anions including creatine phosphate, succinate, and pyruvate across the mitochondrial outer membrane (Hodge and Colombini, 1997). The inner membrane contains the adenine nucleotide translocator (ANT), which regulates the ATP/ADP transport between the matrix and the intermembrane space. Continuous exchange of ATP/ADP across the VDAC/ANT channels is crucial for ATP synthase to produce ATP by dissipating proton gradient generated by the electron flow through the electron transport chain. Therefore, limitation of the substrate for ATP synthase due to the defect of the VDAC/ANT channels causes inner membrane hyperpolarization by the accumulation of hydrogen ion in the intermembrane space. This leads to increased production of reactive oxygen species (ROS) and matrix swelling, ultimately causing mitochondrial dysfunction and cell death (Vander Heiden and Thompson, 1999). BCL-X<sub>L</sub> was shown to prevent growth factor withdrawal-induced cell death by maintaining ATP/ADP transport across the mitochondrial outer membrane through keeping VDAC in its open configuration (Vander Heiden et al., 1999; Vander Heiden et al., 2000; Vander Heiden et al., 2001).

Besides releasing cytochrome *c* directly from mitochondria, multidomain pro-apoptotic BCL-2 members also contribute to mitochondrial dysfunction that elicits cell death. BAX overexpression triggers cell death in the presence of caspase inhibitors, suggesting the existence of caspase-independent mitochondrial dysfunction (Xiang et al.,

1996). Moreover, it was shown that overexpression of BH3s kills *Apaf-1*- or *caspase*-deficient cells by caspase-independent mitochondrial dysfunction (Cheng et al., 2001). BAX was shown to induce mitochondrial hyperpolarization and growth arrest in *S. cerevisiae*, which was dependent on the presence of respiratory chain components suggesting that BAX-induced cell death requires respiratory activity to generate ROS or affect ATP production (Gross et al., 2000; Harris et al., 2000). Taken together, BCL-2 family proteins play an essential role in regulating not only mitochondria-dependent caspase activation but also mitochondrial physiology.

### **1.7. Significance**

Our understanding of BCL-2 family members and how their interactions determine the cellular commitment to apoptosis have substantially expanded over the past decades. Thanks to elaborate cell biology, biochemistry, and genetic studies, there is general consensus that BCL-2 subfamily members interact among others to play a unique role in regulating both developmental processes and adult tissue homeostasis via mitochondrion-centered cell death. However, the order of interactions and their relative contributions to cell survival versus death have largely remained unsolved. Although a “two-class” model has been proposed to delineate the functional differences among the different BH3-only sets, a detailed functional map of dynamic interactions among BCL-2 subfamily members has not yet been established. The reagents have been limited to the synthetic peptides derived from the conserved BH3 domain or bacterially expressed proteins of certain BH3s. In addition, the activation process by which BH3s relay apoptotic signals to the downstream effector BAX/BAK is still a matter of intense debate

despite extensive research in the apoptosis field. This has been largely due to the difficulty in capturing the defined structure and conformation of BAX/BAK during the activation process, including interaction with BH3s, translocation/membrane insertion, and oligomerization. Moreover, conflicting experimental results regarding the intermolecular binding partners of proapoptotic BAX/BAK in initiating BAX/BAK activation have prevented the formulation of a clear picture of how the BAX/BAK-dependent cell death program is regulated by upstream BH3s. Although the structure of BAX has been revealed by an NMR structural study, how the auto-inhibitory configuration is relieved to initiate BAX translocation to mitochondria is among the few of numerous unanswered questions regarding the activation of BAX.

This thesis addresses some of these critical questions. In chapter 2, I assess the dynamic interconnection among BCL-2 subfamily members and investigate how this intricate interplay governs cellular commitment to survival versus death. In chapter 3, I dissect the molecular mechanism by which BAX/BAK is activated by upstream BH3s to initiate the mitochondrial apoptotic program. In chapter 4, I expand the scope of my thesis to study how activated BAK triggers mitochondrial dysfunction to promote cell death independently of cytochrome *c*-initiated caspase activation.

In summary, the work described here will substantially improve the current understanding of how BCL-2 family members regulate mitochondrion-dependent cell death program. In addition, it gives new insights into how the proapoptotic BCL-2 member can integrate the core apoptotic cell death pathway and mitochondrial physiology to determine cellular life and death.



## 1.8. Figure legends

### **Figure 1.1. Schematic summary of three BCL-2 subfamily members**

BCL-2 family members are divided into three subfamilies based on the composition of BCL-2 homology (BH) domains and their death regulatory activities.

### **Figure 1.2. The NMR Structure comparison of BAX monomer and BCL-X<sub>L</sub>/BAK BH3 peptide complex**

(A) Ribbon representation of BAX structure that shows auto-inhibitory conformation. Each nine  $\alpha$ -helix is designated with a different color.

(B) Ribbon representation of BCL-X<sub>L</sub> complexed to the BAK BH3 domain (GQVGRQLAIIGDDINR) peptide. The BAK BH3 peptide (gold) binds to a hydrophobic cleft formed by the BH1, BH2, and BH3 domains of BCL-X<sub>L</sub>.

Bottom panels: close-up views of the hydrophobic pocket occupied by the  $\alpha$ 9 helix of BAX, and a similar view of the peptide-binding pocket in BCL-X<sub>L</sub>. Overall configuration of the complex between BCL-X<sub>L</sub>/BAK BH3 and BAX/ $\alpha$ 9 helix exhibits high similarity although the BAK peptide is bound to the hydrophobic pocket in reverse orientation to the  $\alpha$ 9 helix of BAX. (Mitchell, 2001)

### **Figure 1.3. Schematic model of pro-apoptotic activation cascade**

The pro-apoptotic tBID ligand allosterically regulates the activation of death receptor BAK to integrate the apoptotic pathway from upstream death signals to cytochrome *c* release from mitochondria. (Korsmeyer, 2000)

## 1.9. Figures

Figure 1.1

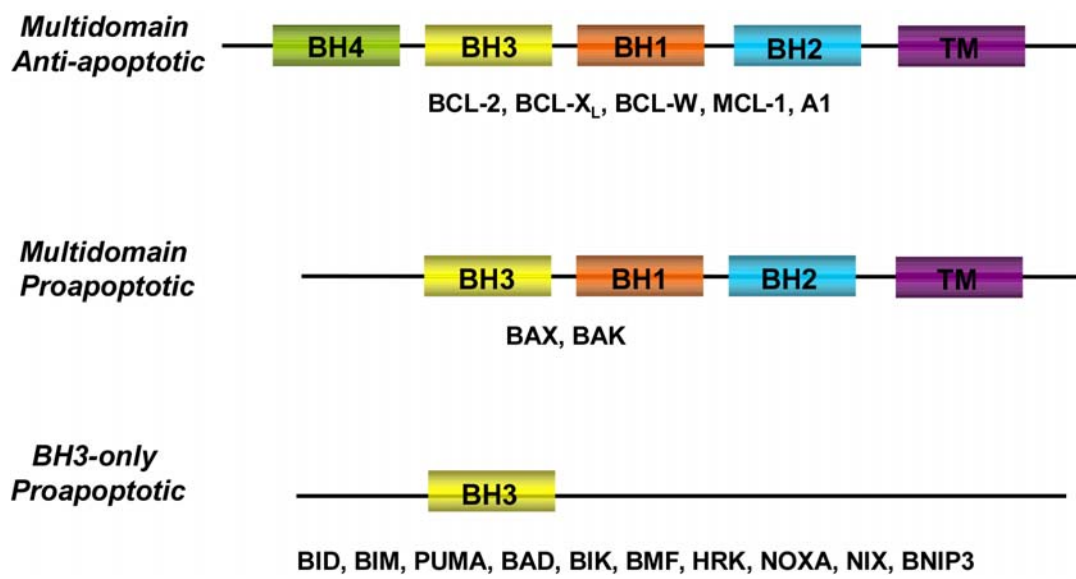
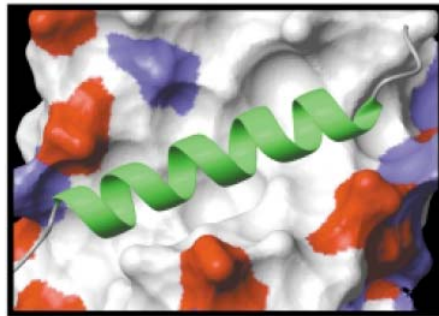
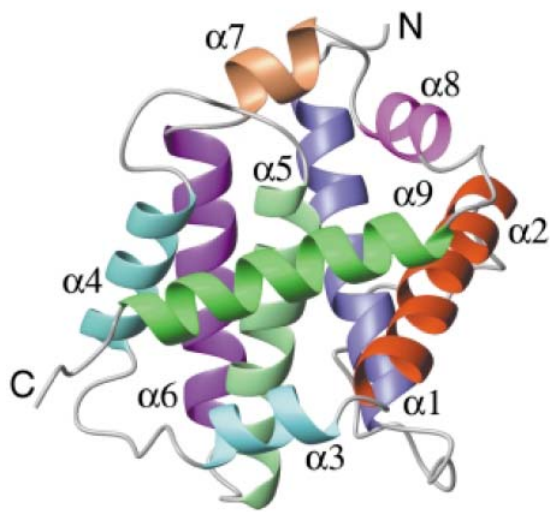

Figure 1.2

A. BAX



B. BAK BH3/BCL-X<sub>L</sub>

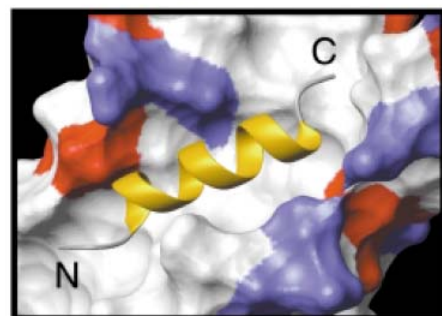
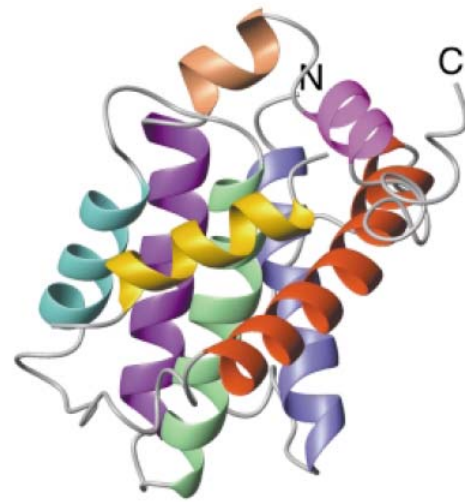
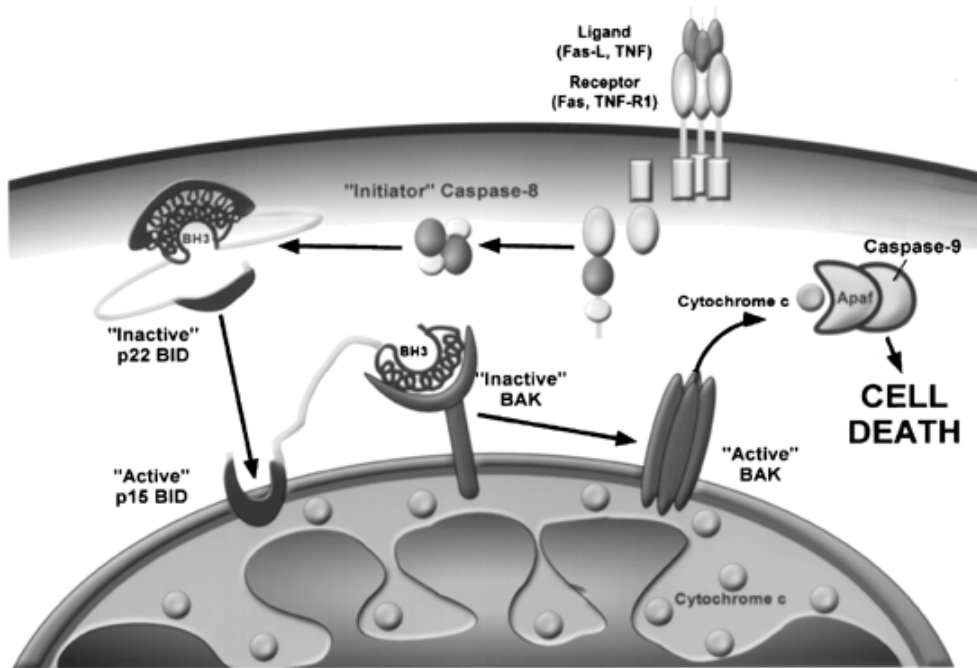

Figure 1.3



**- CHAPTER 2 -**

**Hierarchical Regulation of Mitochondrion-Dependent Apoptosis**

**By BCL-2 Subfamilies**

(The content of this chapter was published as Kim et al., (2006) Nature Cell Biol. 8:1348-

58)

## 2.1. Summary

Although the BCL-2 family constitutes a crucial checkpoint in apoptosis, the intricate interplay between these family members remains elusive. Here, we demonstrate that BIM and PUMA, similar to truncated BID (tBID), directly activate BAX/BAK to release cytochrome *c*. Conversely, anti-apoptotic BCL-2/BCL-X<sub>L</sub>/MCL-1 sequesters these ‘activator’ BH3-only molecules into stable complexes, thus preventing the activation of BAX/BAK. Extensive mutagenesis of BAX/BAK indicates that their activity is not kept in check by BCL-2/BCL-X<sub>L</sub>/MCL-1. Anti-apoptotic BCL-2 members are differentially inactivated by the remaining ‘inactivator’ BH3-only molecules including BAD, NOXA, BMF, BIK/BLK and HRK/DP5. BAD displaces tBID, BIM or PUMA from BCL-2/BCL-X<sub>L</sub> to activate BAX/BAK, whereas NOXA specifically antagonizes MCL-1. Coexpression of BAD and NOXA killed wild-type but not *Bax/Bak* doubly deficient cells or *Puma* deficient cells with *Bim* knockdown, indicating that activator BH3-only molecules function downstream of inactivator BH3-only molecules to activate BAX/BAK. Our data establish a hierarchical regulation of mitochondrion-dependent apoptosis by various BCL-2 subfamilies.

## 2.2. Introduction

Apoptosis, or programmed cell death, results from the activation of an evolutionarily conserved genetic pathway (Horvitz, 2003). Apoptosis manifests in irreversible damage to cellular constituents through caspase activation and mitochondrial dysfunction (Danial and Korsmeyer, 2004; Degterev et al., 2003). Mammals evolved a more complex regulation of caspase activation with the involvement of mitochondria, namely the requirement for cytochrome *c* (Green and Reed, 1998; Wang, 2001). The BCL-2 family members are major regulators of mitochondrial integrity and mitochondrion-initiated caspase activation (Cory and Adams, 2002).

The BCL-2 family possesses both anti-apoptotic and proapoptotic members and is divided into three subclasses, defined by the homology shared within four conserved BCL-2 homology domains (BH1–4) (Cory and Adams, 2002; Danial and Korsmeyer, 2004). The anti-apoptotics, including BCL-2, BCL-X<sub>L</sub>, MCL-1, A1 and BCL-W, display sequence conservation through BH1–4. Proapoptotics are further subdivided into more fully conserved, 'multidomain' members (BAX and BAK) possessing homology in BH1–3 or BH3-only molecules (BH3s). Cells deficient for BAX and BAK proved resistant to tested intrinsic death signals (Lindsten et al., 2002; Wei et al., 2001). In viable cells, multidomain proapoptotics exist as inactive monomers in the cytosol (BAX) or at the mitochondria (BAK) (Hsu et al., 1997). Genetic and biochemical studies indicate that voltage-dependent anion channel (VDAC)-2 is a specific inhibitor of BAK (Cheng et al., 2003). Following death stimuli, BAX inserts into the mitochondrial outer membrane (MOM) as homo-oligomers, while BAK also homo-oligomerizes, resulting in the

permeabilization of the MOM with release of intermembrane space (IMS) proteins, including cytochrome *c* (Wei et al., 2000; Antonsson et al., 2001). Deficiency of BAX and BAK conferred long-term protection from apoptosis triggered by all BH3s, positioning the BH3-only subfamily upstream of multidomain BAX/BAK (Cheng et al., 2001; Zong et al., 2001).

Recently, peptides of the  $\alpha$ -helical BH3 domains provided evidence for a two-class model in which BID and BIM directly activated BAX/BAK, whereas the BAD- and NOXA-like BH3 peptides served as 'sensitizing' or 'derepressor' domains capable of antagonizing BCL-2-, BCL-X<sub>L</sub>- or MCL-1-mediated inhibition of BID (Kuwana et al., 2005; Letai et al., 2002). However, it remains unclear whether fragments of 25–26 amino acids recapitulate the activity of full-length proteins in regulating apoptosis. Furthermore, the significance of such classification has not been fully validated *in vivo*. Emerging evidence suggests that anti-apoptotic BCL-2s are selectively inactivated by different BH3s, but most studies were only focused on BAD/NOXA or based on studies of BH3 peptides (Chen et al., 2005; Kuwana et al., 2005; Letai et al., 2002). A detailed functional map of how BH3s antagonize anti-apoptotic BCL-2s is absent. Finally, it remains debatable whether anti-apoptotic BCL-2s directly inhibit BAX/BAK and/or sequester BH3s.

Here, we reassessed the 'two-class' model of BH3s using full-length proteins and found that similarly to tBID, both BIM and PUMA were activators of BAX/BAK. The remaining BH3s selectively inactivated anti-apoptotics by preventing their sequestration of activator BH3s. Moreover, we demonstrated that BIM and PUMA were required for BAD and NOXA to kill cells, establishing the hierarchy of the proapoptotic BCL-2



signaling cascade. Finally, instructive mutants of BAX and BAK indicated that their activity was not kept in check by anti-apoptotic BCL-2/BCL-X<sub>L</sub>/MCL-1. The principal role of anti-apoptotic BCL-2s in preventing apoptosis is to tie up activator BH3s, thereby preventing these activators from triggering BAX/BAK activation. Our studies provide insights into how the interplay between various BCL-2 subfamilies determines cell commitment to survival versus death.

## **2.3. Materials and Methods**

### **Plasmid construction and retrovirus production**

The indicated Bcl-2 members were cloned into pSG5 (Stratagene, La Jolla, CA) or pCDNA3 (Invitrogen, Carlsbad, CA) for IVTT experiments and the retroviral expression vector MSCV-IRES-GFP (pMIG) or MSCV-Puro (Clontech, Mountain View, CA). Mutant *Bax* (L70A and D71A) and mutant *Bak* (I82A and N83A) were generated by PCR-based site-directed mutagenesis. All the constructs were confirmed by DNA sequencing. *Bim*-knockdown construct cloned into pSuper-Retro-Puro (Oligoengine, Seattle, WA) was described previously (Harada et al., 2004). The production of amphotropic retroviruses using 293GPG packing cell line was performed as described previously (Cheng et al., 2001). Retroviral plasmids were transfected using FuGene (Roche, Mannheim, Germany) according to the manufacturer's protocols. Retroviral transduction of each indicated BCL-2 family protein was confirmed by Western blotting.

### **Cell culture, cell transfection and viability assay**

All the MEFs used in the experiments were SV40 transformed and maintained in Dulbecco's modified Eagles medium supplemented with 10% fetal bovine serum following standard culture conditions and procedures. Reconstitution of BAX or BAK into DKO cell was achieved by retroviral transduction of BAX-IRES-GFP or BAK-IRES-GFP, followed by MoFlo (DakoCytomation, Carpinteria, CA) sorting for GFP-positive cells. Expression plasmids were transfected using Lipofectamine 2000

(Invitrogen) according to the manufacturer's instructions. Cell death was quantified by Annexin-V–Cy3 (BioVision, Mountain View, CA) staining according to manufacturer's protocols, followed by flow cytometric analysis using a FACS Caliber (BD Bioscience, San Jose, CA) and CellQuest software. *P* values for statistical analyses were obtained using Student's *t* test.

### **Peptides and *in vitro* transcription-translation of proteins**

BH3 peptides of NOXA (VPADLKDECAQLRRIGDKVNLRQKL) and BAD (NLWAAQRYGRELRRMs.d.EFVDSFKK) were synthesized by Tufts University Core Facility (Boston, MA). *In vitro* transcription and translation reactions were performed with TNT Quick Coupled Transcription/Translation Systems (Promega, Madison, WI) with non-radiolabeled or <sup>35</sup>S-labelled methionine (Amersham, Piscataway, NJ). All the constructs generated full-length BCL-2 family proteins with the expected molecular weights detected by autoradiography.

### **Cytochrome *c*-release assay, protein crosslinking and mitochondrial targeting of BH3-only molecules**

Mitochondria purification and cytochrome *c*-release assays were performed as described previously (Cheng et al., 2001). Quantitation of cytochrome *c* release was performed using colorimetric ELISA assays (MCTC0; R&D Systems, Minneapolis, MN). To obtain the percentage of cytochrome *c* release, the amount of cytochrome *c* present in mitochondrial supernatant was divided by total cytochrome *c* present in both mitochondrial supernatant and pellet. Crosslinking of BAX and BAK was performed as

previously described (Cheng et al., 2001; Cheng et al., 2003). Briefly, 10 mM solution of bismaleimido-hexane (BMH) or disuccinimidyl suberate (DSS) cross-linker (Pierce, Rockford, IL) in DMSO was added to mitochondria for 30 min at room temperature. Mitochondrial targeting of *in vitro* transcribed-translated BH3-only proteins was previously described (Wei et al., 2000).

### **Antibodies, Western blot analysis and coimmunoprecipitation**

Antibodies used for Western blot analyses included: anti-BAK (Upstate Biotechnology, Lake Placid, NY), anti-BAX (N-20, Santa Cruz Biotechnology, Santa Cruz, CA), anti-MCL-1 (S-19, Santa Cruz Biotechnology), polyclonal anti-BCL-X<sub>L</sub> (Cell Signaling Technology, Beverly, MA), monoclonal anti-BCL-X<sub>L</sub> (7B2, Southern Biotech, Birmingham, AL), anti-BCL-2 (6C8 or 3F11, BD Bioscience), anti-BAD (C-20, Santa Cruz Biotechnology), anti-BMF (Cell Signaling Technology) and anti-NOXA (Invitrogen). Cell or mitochondria lysates were resolved by 10% NuPAGE (Invitrogen) gels, transferred onto PVDF membrane (Immobilon-P, Millipore, Bedford, MA). Antibodies were detected using the enhanced chemiluminescence method (Western Lightning, Perkin Elmer, Boston, MA) and LAS-3000 Imaging system (FUJIFILM Life Science, Tokyo, Japan). For coimmunoprecipitation, cells were lysed in 0.2% NP40 isotonic buffer (0.2% NP40, 142.5 mM KCl, 5 mM MgCl<sub>2</sub>, 1 mM EGTA, 20 mM HEPES at pH 7.5) supplemented with complete protease inhibitors (Roche). Cell lysates were immunoprecipitated with anti-HA antibody (12CA5), anti-MCL-1 antibody (S-19, Santa Cruz Biotechnology), Anti-BCL-X<sub>L</sub> antibody (7B2.5), or anti-BCL-2 (3F11) antibody and separated by 10% NuPAGE (Invitrogen) gels.

### **Immunoprecipitation of *in vitro* transcribed-translated proteins**

Cotranslated proteins were immunoprecipitated with anti-HA antibody (12CA5) in 0.2% NP40 isotonic buffer supplemented with complete protease inhibitors (Roche). Immunoprecipitates were separated in 10% NuPAGE (Invitrogen) gels and detected by autoradiography. For competition experiments, non-radiolabeled IVTT BH3-only proteins serving as cold competitors were added at 1:1, 2.5:1 or 5:1 ratio compared with radiolabeled proteins.

## 2.4. Results

### ***BID, BIM and PUMA are activator BH3s that directly activate BAX/BAK***

Among BH3s, only tBID has been shown to exhibit cytochrome *c* releasing activity *in vitro* (Li et al., 1998; Luo et al., 1998). As most studies used BH3 peptides (Kuwana et al., 2005; Letai et al., 2002), it remains unclear whether peptides reflect the function of full-length proteins. We undertook a systematic approach to investigate the cytochrome *c*-releasing activity of ten BH3s using a coupled *in vitro* transcribed–translated (IVTT) system. IVTT proteins of tBID, BIM-EL and PUMA effectively released cytochrome *c* from isolated mitochondria, whereas BAD, NOXA, BMF, BLK, HRK, BNIP3, and NIX failed to induce cytochrome *c* efflux with comparable mitochondrial targeting (Fig. 2.1A and Fig. S2.1A, B). Accordingly, the BH3s directly releasing cytochrome *c* were more potent death agonists (Fig. 2.1B and Fig. S2.1C, D). Retroviral transduction of tBID, BIM or PUMA in mouse embryonic fibroblasts (MEFs) resulted in >65% death at 24 h, whereas the remaining BH3s only induced <25% of apoptosis (Fig. 2.1B). The differential activity of BH3s was not due to quantitative difference (Fig. S2.1A, C).

Single amino-acid substitutions or a deletion of seven amino-acid residues within the BH3 domain abolished the cytochrome *c* releasing activity of tBID, BIM-EL or PUMA, indicating that BH3 domain is essential for mitochondrial permeabilization (Fig. 2.1C). Moreover, mitochondria isolated from *Bax/Bak* double knockout (DKO) MEFs proved resistant to tBID-, BIM-, or PUMA-induced cytochrome *c* translocation (Fig. 2.1C). By analogy to tBID, BIM and PUMA directly activated BAX/BAK, resulting in

homo-oligomerization of BAX/BAK (Fig. 2.1D, E). Consequently, mitochondria isolated from either *Bax*<sup>-/-</sup> or *Bak*<sup>-/-</sup> cells were sensitive to tBID/BIM/PUMA-induced cytochrome *c* release (data not shown). We have previously demonstrated that VDAC2 specifically interacts with the inactive BAK conformer, preventing BAK activation (Cheng et al., 2003). On apoptotic signals or treatment of mitochondria with tBID, BAK was released from VDAC2 to homo-oligomerize. Here, we showed that addition of BIM or PUMA to isolated mitochondria dissociated the BAK-VDAC2 complexes (Fig. 2.1F). Importantly, the BH3s lacking cytochrome *c* releasing activity were incapable of disrupting BAK/VDAC2 association or inducing BAX/BAK oligomerization (data not shown).

***BAK and BAX are not kept in check by BCL-2, BCL-X<sub>L</sub> or MCL-1***

In addition to VDAC2, BCL-X<sub>L</sub> and MCL-1 have been reported to keep BAK in check (Cuconati et al., 2003; Willis et al., 2005). We, and others, have shown that BCL-2 is unlikely to control BAK activation as it lacks binding to the inactive BAK conformer (Cheng et al., 2003; Willis et al., 2005) (Fig. S2.2A). To further investigate BAK activation, extensive mutagenesis of BAK was performed in an attempt to generate BAK mutants that no longer interact with BCL-X<sub>L</sub>/MCL-1. If such a mutant were not a loss-of-function mutant, it would be constitutively active under the assumption that BAK is solely inhibited by BCL-X<sub>L</sub>/MCL-1. A BAK mutant (BAK<sup>I82A & N83A</sup>) failed to be coprecipitated with HA-tagged BCL-X<sub>L</sub> or MCL-1 before or during apoptosis (Fig. 2.2A-D). Reconstitution of this *Bak* mutant into DKO cells to a physiological level (Fig. S2.2B) restored killing by staurosporine and etoposide (Fig. 2.2E). Importantly, this mutant did not induce apoptosis without death stimuli despite its inability to heterodimerize with

BCL-X<sub>L</sub>/MCL-1, indicating that it must be regulated by proteins other than BCL-X<sub>L</sub>/MCL-1. Indeed, this mutant was crosslinked to VDAC2 and coprecipitated with VDAC2 like wild-type BAK (Fig. 2.2F and Fig. S2.2C), suggesting that it was still inhibited by VDAC2. Furthermore, endogenous BCL-X<sub>L</sub> and MCL-1 could not be crosslinked to BAK (Fig. S2.2D).

As BCL-X<sub>L</sub> and MCL-1 were identified as cytosolic inhibitors of mitochondrial permeabilization, and MCL-1 was proposed to play a pivotal role upstream of BAX translocation (Nijhawan et al., 2003), we tested whether BCL-X<sub>L</sub> and MCL-1 are pertinent to BAX activation. A BAX mutant (BAX<sup>L70A & D71A</sup>) that failed to be coprecipitated with endogenous BCL-X<sub>L</sub> or MCL-1 before or during apoptosis still conferred full or partial killing of DKO cells by staurosporine and etoposide, respectively (Fig. 2.3A-C). This BAX mutant also failed to interact with BCL-2 (Fig. S2.2E). As different BH3s are likely to be activated by staurosporine versus etoposide, this BAX mutant may be selectively activated by different BH3s. The instability of this BAX mutant protein following etoposide treatment also contributed to its inability to fully confer death susceptibility to DKO cells (Fig. 2.3C and Fig. S2.2B). Moreover, overexpression of BCL-X<sub>L</sub>, MCL-1 or BCL-2 in DKO cells reconstituted with either BAK<sup>I82A & N83A</sup> or BAX<sup>L70A & D71A</sup> protected cells from apoptosis (Fig. 2.3D, E and Fig. S2.2F), indicating that BCL-X<sub>L</sub>/MCL-1/BCL-2 does not inhibit apoptosis by directly antagonizing BAX/BAK.

***Anti-apoptotic BCL-2s inhibit apoptosis by sequestering activator BH3s***



To interrogate how anti-apoptotic BCL-2s inhibit apoptosis, we examined whether the ability of anti-apoptotic BCL-2s to prevent apoptosis triggered by activator BH3s correlated with their sequestration of these BH3s. HA-tagged BCL-2, BCL-X<sub>L</sub> and MCL-1 coprecipitated tBID, BIM and PUMA effectively (Fig. 2.4A). Previously reported loss-of-function mutants of BCL-2 and BCL-X<sub>L</sub> were included as negative controls (Cheng et al., 2001). Consequently, overexpression of BCL-2, BCL-X<sub>L</sub> or MCL-1 completely blocked apoptosis triggered by tBID, BIM or PUMA (Fig. 2.4B). Moreover, BCL-2/BCL-X<sub>L</sub>/MCL-1 protected DKO cells reconstituted with either BAK<sup>I82A & N83A</sup> or BAX<sup>L70A & D71A</sup> from BIM-induced apoptosis (Fig. 2.4C). Thus, the anti-apoptotic BCL-2s act as sequestration sinks to tie up BH3-only activators of BAX/BAK, thus preventing the activation of BAX/BAK.

To further confirm that activator BH3s activate BAX/BAK independent of anti-apoptotic BCL-2s, we performed mutagenesis of tBID. One BH3 mutant of tBID (tBID<sup>M97A & D98A</sup>) completely lost interaction with anti-apoptotic BCL-2/BCL-X<sub>L</sub>/MCL-1, but still induced apoptosis (Fig. 2.4D, E). These data not only highlight that activator BH3s induce apoptosis by directly activating BAX/BAK instead of inactivating anti-apoptotic BCL-2s, but also suggest that endogenous BAX/BAK is not kept in check by anti-apoptotic BCL-2s.

***Inactivator BH3s displace activator BH3s from anti-apoptotic BCL-2s to activate BAX–BAK***

BH3s have been proposed to selectively inactivate anti-apoptotic BCL-2s based on their interaction specificity. BAD bound well with BCL-2 and BCL-X<sub>L</sub>, but not MCL-

1, whereas NOXA interacted only with MCL-1 (Chen et al., 2005; Kuwana et al., 2005; Letai et al., 2002; Opferman et al., 2003). Based on our model that anti-apoptotic BCL-2s inhibit apoptosis by sequestering the activator BH3s, one possibility is that the remaining BH3s prevent anti-apoptotic BCL-2s from sequestering activator BH3s. MCL-1/BIM or BCL-X<sub>L</sub>/BIM heterodimers were detected by anti-HA immunoprecipitation of *in vitro* cotranslated BIM and HA-tagged MCL-1 or BCL-X<sub>L</sub> (Fig. 2.5A). NOXA reduced the heterodimerization between MCL-1 and BIM in a dose-dependent manner, whereas BAD effectively disrupted BCL-X<sub>L</sub>/BIM complexes (Fig. 2.5A). In contrast, BMF failed to abolish either MCL-1/BIM or BCL-X<sub>L</sub>/BIM interactions (Fig. 2.5A). To determine the functional relevance of these selective displacement reactions, we tested whether the expression of BAD, NOXA, BMF or BLK triggered apoptosis in cells coexpressing MCL-1/BIM or BCL-X<sub>L</sub>/BIM. We first expressed an equimolar ration of MCL-1 or BCL-X<sub>L</sub> versus BIM in wild-type MEFs using a retroviral system in which MCL-1 or BCL-X<sub>L</sub> expression was coupled to that of BIM through an internal ribosomal entry site (IRES). Coexpression of MCL-1 or BCL-X<sub>L</sub> abolished BIM-induced apoptosis. Subsequent expression of NOXA, but not BAD, BMF or BLK, triggered apoptosis in cells coexpressing MCL-1 and BIM (Fig. 2.5B). In contrast, only BAD killed cells coexpressing BCL-X<sub>L</sub> and BIM (Fig. 2.5B). The selective killing of BAD and NOXA was not observed in cells that only express BCL-X<sub>L</sub> or MCL-1, or in DKO cells (data not shown), indicating that BIM and BAX/BAK were essential downstream effectors of BAD/NOXA. The activity of these inactivator BH3s was also examined in cells expressing BCL-2 and BIM. BAD, but not NOXA, BMF or BLK, induced more apoptosis in cells expressing BCL-2 and BIM in comparison with wild-type cells (Fig.

2.5C). Similar findings were observed in PUMA-induced apoptosis in which BAD abolished the protection conferred by BCL-2 and BCL-X<sub>L</sub>, whereas NOXA antagonized MCL-1 (Fig. 2.5D and Fig. S2.3A). One critical question was whether NOXA and BAD were able to displace BIM or PUMA from anti-apoptotic BCL-2s to activate BAX/BAK. Indeed, the BAD BH3 peptide induced cytochrome *c* release in isolated mitochondria expressing BCL-X<sub>L</sub>/PUMA but not MCL-1/PUMA (Fig. 2.5E). Reciprocally, the NOXA BH3 peptide only permeabilized mitochondria expressing MCL-1/PUMA (Fig. 2.5E).

We further investigated the effect of BAD/NOXA/BMF/BLK in opposing BCL-2/BCL-X<sub>L</sub>/MCL-1-mediated inhibition of tBID-induced apoptosis. Expression of tBID killed wild-type, but not BCL-2/BCL-X<sub>L</sub>/MCL-1 overexpressing cells (Fig. 2.5F, G and Fig. S2.3B). Coexpression of BAD, BMF or BLK with BCL-2 or BCL-X<sub>L</sub> abrogated the protective effect of BCL-2 or BCL-X<sub>L</sub> against tBID (Fig. 2.5F, G). In contrast, NOXA had minimal effect on the anti-apoptotic activity of BCL-2/BCL-X<sub>L</sub> (Fig. 2.5F, G). These functional readouts were supported by the biochemical assays showing that BMF, but not NOXA, displaced tBID from BCL-X<sub>L</sub> (Fig. 2.5H). This was in stark contrast to the inability of BMF to antagonize BCL-X<sub>L</sub> against BIM because BMF was unable to release BIM from BCL-X<sub>L</sub> (Fig. 2.5A, B). Therefore, the ability of individual inactivator BH3s to antagonize specific anti-apoptotic BCL-2s is not simply determined by whether they interact. Instead, the relative binding affinity between activator or inactivator BH3s and anti-apoptotic BCL-2s governs the decision of survival or death (Table 2.1). Similarly to MCL-1-mediated inhibition of BIM, NOXA diminished the anti-apoptotic activity of MCL-1 against tBID (Fig. S2.3B).

It has been reported that BAD and NOXA cooperated to kill cells through simultaneous inhibition of BCL-X<sub>L</sub> and MCL-1 (Chen et al., 2005). Coexpression of BAD and NOXA was as potent as tBID/BIM/PUMA for inducing apoptosis in wild-type cells, but not in DKO cells, highlighting the essential role of BAX/BAK for the synergistic killing by BAD and NOXA (Fig. 2.6A). The cooperative effect of BAD and NOXA was equally evident in *Bax* or *Bak* single-knockout cells, indicating that either BAX or BAK alone could serve as a downstream effector (data not shown). As BAD and NOXA are unable to activate BAX/BAK, they must displace endogenous activator BH3s that are sequestered by BCL-2/BCL-X<sub>L</sub>/MCL-1 to activate BAX/BAK. BIM and PUMA would be obvious candidates as BID was not cleaved or activated by coexpression of BAD and NOXA (data not shown). Displacement of BIM by NOXA from MCL-1 was also demonstrated on DNA damage (Fig. S2.3E). Retrovirus-mediated stable knockdown of *Bim* conferred a statistically significant protective effect against apoptosis triggered by BAD and NOXA (Fig. 2.6A). Similarly, *Puma* homozygous-knockout cells exhibited decreased apoptosis induced by BAD and NOXA as compared with *Puma* heterozygous-knockout cells (Fig. 2.6B). Most importantly, knockdown of *Bim* in *Puma* homozygous-knockout cells provided marked protection against BAD- and NOXA-induced death (Fig. 2.6B). Notably, these cells were still susceptible to PUMA-induced apoptosis (Fig. S2.3C). Although the lesser protection compared with DKO cells may simply reflect an incomplete *Bim* knockdown (Fig. S2.3D), we could not exclude the possible existence of yet identified activator BH3s. Nevertheless, these data establish a hierarchy for the proapoptotic BCL-2 signaling cascade in which activator BH3s, such as BIM and PUMA,

act downstream of inactivator BH3s, such as BAD and NOXA, to trigger BAX/BAK-dependent death (Fig. 2.7).

### ***Differential regulation of anti-apoptotic BCL-2s by inactivator BH3s***

To define the specificity of inactivator BH3s against anti-apoptotic BCL-2s, we extended our studies to investigate the effect of BAD/NOXA/BMF/BLK/HRK on BCL-2/BCL-X<sub>L</sub>/MCL-1 in response to staurosporine, etoposide, tunicamycin, thapsigargin and glucose withdrawal (Fig. 2.8 and Fig. S2.4A). We have established that BCL-2 and BCL-X<sub>L</sub> are similarly affected by inactivator BH3s in response to death induced by tBID/BIM/PUMA, whereas MCL-1 was only inactivated by NOXA (Table 2.1). One critical question is whether BCL-2 and BCL-X<sub>L</sub> are functionally equivalent. The anti-apoptotic activity of BCL-2 and BCL-X<sub>L</sub> against diverse death stimuli was differentially regulated by BAD, BMF, BLK and HRK (Fig. 2.8A, B). None of the inactivator BH3s was able to antagonize BCL-X<sub>L</sub> against staurosporine-induced apoptosis, whereas each of the BH3s, with the exception of NOXA, almost completely abolished the activity of BCL-X<sub>L</sub> in glucose-deprivation-induced death (Fig. 2.8B). BCL-2 was less opposed by inactivator BH3s compared with BCL-X<sub>L</sub> in tunicamycin- and thapsigargin-induced death (Fig. 2.8A, B). Although it has been reported that HRK interacts with both BCL-2 and BCL-X<sub>L</sub> (Inohara et al., 1997), HRK selectively inhibited BCL-X<sub>L</sub> (Fig. 2.8A, B).

BMF was originally cloned as an MCL-1-interacting protein (Puthalakath et al., 2001), even though it did not bind as tightly as NOXA to MCL-1 (Fig. S2.4B). The physiological relevance of MCL-1/BMF interaction was reflected by the ability of BMF to antagonize MCL-1 in staurosporine-, etoposide- and thapsigargin-induced apoptosis

(Fig. 2.8C). As both activator and inactivator BH3s could be activated by these death stimuli, our assays potentially reflected additive or synergistic effects between the tested inactivator BH3s and those induced. Our data provided evidence that BCL-2, BCL-X<sub>L</sub> and MCL-1 are not functionally equivalent.

## 2.5. Discussion

Although multidomain proapoptotic BAX and BAK are essential downstream effectors controlling the mitochondrion-dependent cell-death program, they need to be activated by the activator BH3s — BID, BIM and PUMA. Contradictory to previous reports showing that bacterially expressed BIM and PUMA were unable to trigger cytochrome *c* efflux (Cartron et al., 2004; Chipuk et al., 2005; Terradillos et al., 2002), we observed potent cytochrome *c* releasing activity of both IVTT proteins. As <1 ng of BIM/PUMA was generated by IVTT, less than 1 nM of BIM/PUMA was sufficient to mobilize all the intramitochondrial cytochrome *c*. This discrepancy may reflect misfolding of bacterially expressed BIM/PUMA. Alternatively, post-translational modification, such as phosphorylation, may be required to activate BIM/PUMA. The three isoforms of BIM exhibited comparable activity. Finally, the observation that the PUMA BH3 peptide is incapable of releasing cytochrome *c* further highlights the importance of using full-length molecules. Recently, cytosolic PUMA was proposed to displace p53 from BCL-X<sub>L</sub>, allowing p53 to permeabilize mitochondria (Chipuk et al., 2005). Notably, p53 is at least 1,000 times less potent than PUMA in inducing mitochondrial permeabilization (Mihara et al., 2003). Consistent with a previous report that PUMA was localized at the mitochondria (Nakano and Vousden, 2001), we were able to utilize BAD or NOXA BH3 peptides to displace PUMA from BCL-X<sub>L</sub> or MCL-1 from isolated mitochondria to release cytochrome *c*. Most importantly, PUMA effectively triggered cytochrome *c* efflux in p53 null cells (Fig. S2.1E)

Heterodimerization between multidomain proapoptotic and anti-apoptotic BCL-2s is one of the signature characteristics of the BCL-2 family. However, functional

correlation of this heterodimerization is ambiguous. BAK was reported to interact selectively with BCL-X<sub>L</sub> and MCL-1, but not BCL-2, BCL-W, and A1 (Willis et al., 2005). Nevertheless, both BCL-2 and BCL-X<sub>L</sub> inhibited BAK-dependent apoptosis in *Bax*-deficient cells equally well (data not shown). Our studies clearly demonstrate that BCL-2/BCL-X<sub>L</sub>/MCL-1 efficiently inhibits apoptosis in *Bax/Bak* DKO cells reconstituted with a BAX or BAK mutant that no longer interacts with BCL-2/BCL-X<sub>L</sub>/MCL-1. Therefore, anti-apoptotic BCL-2s do not block apoptosis through direct inhibition of BAX/BAK. Indeed, the anti-death activity of anti-apoptotic BCL-2s correlates well with their ability to sequester BAX/BAK activators (BID/BIM/PUMA). The competition for activator BH3s by multidomain anti-apoptotic and proapoptotic members may help explain why the ratio between these two multidomain subfamilies dictates the susceptibility to death. It is likely that the heterodimerization between multidomain proapoptotic and anti-apoptotic BCL-2s regulates other biological processes, such as calcium homeostasis (Li et al., 2002; Scorrano et al., 2003). Notably, the anti-apoptotic BCL-2s display much higher affinity for activator BH3s compared with proapoptotic BAX/BAK. The implication is that BAX/BAK will not be activated until all the hydrophobic pockets of anti-apoptotic BCL-2s are saturated with BH3s, thus providing a fail-safe mechanism to avoid unnecessary BAX/BAK activation. Interestingly, it seems that most, and probably all, intrinsic death signals activate both activator and inactivator BH3s simultaneously: DNA damage upregulates PUMA and NOXA (Nakano and Vousden, 2001; Oda et al., 2000; Yu, 2001); NGF deprivation induces BIM and HRK (Imaizumi, 1997; Putcha et al., 2001); and cytokine withdrawal activates BIM and BAD



(Dijkers et al., 2000). Thus, they not only activate BAX/BAK, but also inactivate anti-apoptotic BCL-2s, ensuring that death occurs.

Overexpression of VDAC2 inhibited apoptosis of *Bax*<sup>-/-</sup> cells, but not *Bak*<sup>-/-</sup> cells, supporting a selective role for VDAC2 in BAK-mediated death (Cheng et al., 2003). The specificity of VDAC2 in suppressing BAK was further demonstrated during Wilms Tumour 1 (WT1)-induced apoptosis (Morrison et al., 2005). In contrast, BCL-X<sub>L</sub>/MCL-1 protected both *Bax*<sup>-/-</sup> and *Bak*<sup>-/-</sup> cells from apoptotic insults. Importantly, a BAK mutant (BAK<sup>I82A & N83A</sup>) that failed to bind BCL-X<sub>L</sub>/MCL-1 but retained interaction with VDAC2 was not constitutively active and functioned like wild-type BAK, requiring further activation by BH3s to trigger apoptosis. The potentially lethal BAK was apparently kept in check by VDAC2, but not by BCL-X<sub>L</sub>/MCL-1. Moreover, all the activator BH3s were able to displace BAK from VDAC2, enabling the released BAK to homo-oligomerize. An instructive BAX mutant also argued against a direct role of BCL-2/BCL-X<sub>L</sub>/MCL-1 in antagonizing multidomain proapoptotics.

Anti-apoptotic BCL-2s are not functionally equivalent. Thus, the phenotypes of knockouts deficient for a specific anti-apoptotic BCL-2 may not simply reflect their differential expression in various tissues. Instead, they may be dictated by tissue-specific signaling cascades involving different BH3s. We presented evidence that the activator BH3s were more potent death agonists compared with inactivator BH3s. This is consistent with more profound phenotypes observed in mice deficient for Bid/Bim/Puma compared with those deficient for the inactivator BH3s (Bouillet et al., 1999; Coultas et al., 2004; Imaizumi et al., 2004; Jeffers et al., 2003; Ranger et al., 2003; Shibue et al., 2003; Villunger et al., 2003; Yin et al., 1999). Our data support the hypothesis that

activator BH3s function downstream of anti-apoptotic BCL-2s (Fig. 2.7), which is consistent with the observation that *Bim* deficiency rescues the phenotypes of *Bcl-2* knockout mice (Bouillet et al., 2001).

The increased number of BCL-2 family members and the potential combinatorial interactions among these factors illustrates the complexity that evolved as the mammalian core apoptotic pathway diverged from that of nematode. Our studies provide a unifying, hierarchical regulatory schema to integrate the previously elusive, even contradictory, interplay between various BCL-2 subfamilies. Recently, BH3 mimetics have been developed as anti-cancer therapeutics (Oltersdorf et al., 2005; Walensky et al., 2004). Our characterization of the differential regulation between various BCL-2 subfamilies should help refine the strategies targeted on BCL-2-regulated apoptosis.

## 2.6. Figure and table legends

### **Figure 2.1. BID, BIM and PUMA directly activate BAX and BAK to induce cytochrome *c* release from mitochondria**

(A) Isolated mitochondria were incubated with the indicated IVTT BH3-only proteins for 30 min at 30 °C, after which the release of cytochrome *c* was quantified by ELISA assays.

(B) SV40-transformed wild-type MEFs were infected with retrovirus expressing indicated BH3-only molecules. Cell death was quantified by flow cytometric analyses of Annexin-V staining at 24 h.

(C) Mitochondria isolated from either wild-type or *Bax/Bak* DKO MEFs were incubated with IVTT wild -type or mutant tBID, BIM or PUMA proteins and cytochrome *c* release was quantified by ELISA assays.

(D) Isolated mitochondria were incubated with indicated BH3-only proteins then treated with 10 mM BMH crosslinker. Higher order BAK complexes were identified by an anti-BAK Western blot.

(E) Isolated mitochondria were incubated with indicated BH3-only proteins then treated with 10 mM BMH crosslinker. Higher order BAX complexes were identified by an anti-BAX Western blot.

(F) Isolated mitochondria were incubated with indicated BH3-only proteins then treated with 10 mM DSS crosslinker. BAK–VDAC2 complexes were identified by an anti-BAK Western blot. The values in A, B and C represent the mean  $\pm$  s.d. of three independent experiments. The mitochondria used in A, D, E and F were isolated from SV40-transformed wild-type MEFs.

**Figure 2.2. BAK is kept in check by VDAC2 but not by BCL-X<sub>L</sub> or MCL-1**

(A) Wild-type (WT) or mutant (MT; I82A and N83A) BAK was transiently coexpressed with HA-tagged BCL-X<sub>L</sub> or BCL-X<sub>L</sub> in *Bax/Bak* DKO MEFs. Cells lysed in 0.2 % NP40 lysis buffer were immunoprecipitated with anti-HA antibody and analysed by anti-BAK or anti-BCL-X<sub>L</sub> Western blots.

(B) Wild-type or mutant (I82A and N83A) BAK was transiently coexpressed with HA-tagged MCL-1 in *Bax/Bak* DKO MEFs. Cellular extracts were immunoprecipitated with anti-HA antibody and analysed by anti-BAK or anti-MCL-1 Western blots.

(C) Wild-type MEFs or *Bax/Bak* DKO MEFs reconstituted with mutant BAK (I82A and N83A) were treated with 1.2 μM staurosporine for 6 h. Cellular extracts were immunoprecipitated with anti-BCL-X<sub>L</sub> antibody (7B2) and analysed by anti-BAK or anti-BCL-X<sub>L</sub> Western blots.

(D) Wild-type or mutant (I82A and N83A) BAK was transiently coexpressed with HA-tagged MCL-1 in *Bax/Bak* DKO MEFs, followed by treatment with 1.2 μM staurosporine for 6 h. Cellular extracts were immunoprecipitated with anti-HA antibody and analysed by anti-BAK or anti-MCL-1 Western blots.

(E) Wild-type MEFs or *Bax/Bak* DKO MEFs reconstituted with mutant BAK (I82A and N83A) were treated with staurosporine (1 μM) or etoposide (10 μg/mL) to induce apoptosis. Death is presented as mean ± s.d. of Annexin-V-positive cells at 24 h from three independent experiments.

(F) Wild-type MEFs or *Bax/Bak* DKO MEFs reconstituted with mutant BAK (I82A and N83A) were treated with 10 mM DSS crosslinker. BAK–VDAC2 complexes were detected by an anti-BAK Western blot.

**Figure 2.3. BAK is not kept in check by BCL-X<sub>L</sub> or MCL-1**

(A) Wild-type MEFs or *Bax/Bak* DKO MEFs reconstituted with mutant BAX (L70A and D71A) were lysed in 0.2% NP40 lysis buffer, immunoprecipitated with anti-BCL-X<sub>L</sub> antibody (7B2) and analysed by anti-BAX or anti-BCL-X<sub>L</sub> Western blots. The upper panel represents immunoprecipitation performed in the absence of a death stimulus; the lower panel is immunoprecipitation performed after treatment with 1.2 μM staurosporine for 6 h.

(B) Wild-type MEFs or *Bax/Bak* DKO MEFs reconstituted with mutant BAX (L70A and D71A) were lysed in 0.2% NP40 lysis buffer, immunoprecipitated with anti-MCL-1 antibody and analysed by anti-BAX or anti-MCL-1 Western blots. The upper panel represents immunoprecipitation performed in the absence of a death stimulus; the lower panel is immunoprecipitation performed after treatment with 1.2 μM staurosporine 6 h.

(C) Wild-type MEFs or *Bax/Bak* DKO MEFs reconstituted with mutant BAX (L70A and D71A) were treated with 1 μM staurosporine or etoposide (10 μg/mL) to induce apoptosis.

(D) *Bax/Bak* DKO MEFs reconstituted with mutant BAK (I82A and N83A) were transduced with control retrovirus (MSCV) or retrovirus-expressing BCL-X<sub>L</sub> or MCL-1, and then treated with 1 μM staurosporine to induce apoptosis.

(E) *Bax/Bak* DKO MEFs reconstituted with mutant BAX (L70A and D71A) were transduced with control retrovirus (MSCV) or retrovirus expressing BCL-X<sub>L</sub> or MCL-1, and then treated with 1 μM staurosporine to induce apoptosis. The values in C, D and E represent the mean ± s.d. of three independent experiments. Cell death was quantified by flow cytometric analyses of Annexin-V staining at 24 h.

**Figure 2.4. Anti-apoptotic BCL-2 proteins inhibit apoptosis by sequestering activator BH3-only molecules, preventing them from activating BAX/BAK**

(A) HA-tagged BCL-2, HA-tagged BCL-X<sub>L</sub>, HA-tagged MCL-1, HA-tagged mutant BCL-2 (G145E), or HA-tagged mutant BCL-X<sub>L</sub> (G138E, R139L and I140N) were cotranslated with tBID, BIM or PUMA *in vitro* in the presence of <sup>35</sup>S-methionine. Reticulocyte lysates in 0.2% NP40 lysis buffer were immunoprecipitated with anti-HA antibody and analysed in 10% NuPAGE gels and autoradiography.

(B) Wild-type MEFs stably expressing BCL-2, BCL-X<sub>L</sub> or MCL-1 were transduced with tBID-, BIM- and PUMA-expressing retrovirus.

(C) Wild-type MEFs, *Bax/Bak* DKO MEFs reconstituted with mutant BAK (I82A and N83A) or mutant BAX (L70A and D71A), or *Bax/Bak* DKO MEFs reconstituted with mutant BAK or mutant BAX stably expressing BCL-2, BCL-X<sub>L</sub> or MCL-1, were transduced with control (MIG) or BIM-expressing retrovirus.

(D) HA-tagged BCL-2, HA-tagged BCL-X<sub>L</sub> or HA-tagged MCL-1 was cotranslated with tBID mutant (M97A and D98A) *in vitro* in the presence of <sup>35</sup>S-methionine. Reticulocyte lysates in 0.2% NP40 lysis buffer were immunoprecipitated with anti-HA antibody and analysed in 10% NuPAGE gels and autoradiography.

(E) Wild-type MEFs were transduced with control retrovirus (MIG) or retrovirus expressing either wild-type or mutant (M97A and D98A) tBID. The values in B, C and E represent the mean ± s.d. of three independent experiments. Cell death was quantified by flow cytometric analyses of Annexin-V staining at 24 h.

**Figure 2.5. Activator BH3-only molecules sequestered by anti-apoptotic BCL-2 members can be displaced by inactivator BH3-only molecules to activate BAX/BAK-dependent mitochondrial apoptosis**

(A) BIM and HA-tagged MCL-1 or HA-tagged BCL-X<sub>L</sub> were cotranslated *in vitro* in the presence of <sup>35</sup>S-methionine. Reticulocyte lysates in 0.2 % NP40 lysis buffer without or with increasing amounts of non-radiolabeled IVTT BAD, BMF or NOXA (1:1, 2.5:1 or 5:1 compared with BIM) were immunoprecipitated with anti-HA antibody and analysed by 10 % NuPAGE gels and autoradiography.

(B) Wild-type MEFs or MEFs stably expressing MCL-1-IRES-BIM or BCL-X<sub>L</sub>-IRES-BIM were transduced with indicated BH3-only molecules by retrovirus.

(C) Wild-type MEFs or MEFs stably expressing BCL-2-IRES-BIM were transduced with indicated BH3-only molecules by retrovirus.

(D) Wild-type MEFs or MEFs stably expressing MCL-1-IRES-PUMA or BCL-X<sub>L</sub>-IRES-PUMA were transduced with indicated BH3-only molecules by retrovirus.

(E) Mitochondria isolated from MEFs stably expressing BCL-X<sub>L</sub>-IRES-PUMA or MCL-1-IRES-PUMA were incubated with 20 μM BAD or NOXA BH3 peptides and cytochrome *c* release was quantified by ELISA assays.

(F) Wild-type MEFs or MEFs stably expressing BCL-2, BCL-2-IRES-BAD, BCL-2-IRES-NOXA, BCL-2-IRES-BMF or BCL-2-IRES-BLK were transduced with control MSCV retrovirus or retrovirus expressing tBID.

(G) Wild-type MEFs or MEFs stably expressing BCL-X<sub>L</sub>, BCL-X<sub>L</sub>-IRES-BAD, BCL-X<sub>L</sub>-IRES-NOXA, BCL-X<sub>L</sub>-IRES-BMF or BCL-X<sub>L</sub>-IRES-BLK were transduced with control MSCV retrovirus or retrovirus expressing tBID.

(H) HA-tagged BCL-X<sub>L</sub> and tBID were cotranslated *in vitro* in the presence of <sup>35</sup>S-methionine. Reticulocyte lysates in 0.2 % NP40 lysis buffer without or with increasing amounts of non-radiolabeled IVTT BMF or NOXA (1:1, 2.5:1 or 5:1 compared with tBID) were immunoprecipitated with anti-HA antibody and analysed by 10% NuPAGE gels and autoradiography. Cell death assays performed in B, C, D, F and G were quantified by Annexin-V staining 24 h post-infection. The values in B–G represent the mean ± s.d. of three independent experiments.

**Figure 2.6. BAD and NOXA synergize to trigger apoptosis by displacing BIM and PUMA from anti-apoptotic BCL-2 members to activate BAX and BAK**

(A) Wild-type, *Bax/Bak* DKO MEFs, or wild-type MEFs stably expressing shRNA against *Bim* using pSuper–Retro system were transduced with BAD and/or NOXA expressing retrovirus. Cell death was quantified by Annexin-V staining 24 h post-infection. The values represent the mean ± s.d. of three independent experiments;  $P = 0.0292$  vector control versus *Bim* knockdown.

(B) *Puma*<sup>+/-</sup>, *Puma*<sup>-/-</sup> or *Puma*<sup>-/-</sup> MEFs stably expressing shRNA against *Bim* using pSuper–Retro system were transduced with control MSCV retrovirus or BAD plus NOXA expressing retrovirus. Cell death was quantified by Annexin-V staining 24 h post-infection. The values represent the mean ± s.d. of three independent experiments;  $P = 0.0013$  *Puma*<sup>+/-</sup> versus *Puma*<sup>-/-</sup>;  $P = 0.0053$  *Puma*<sup>-/-</sup> versus *Puma*<sup>-/-</sup> with *Bim* knockdown.

**Figure 2.7. Schematic representation of the mammalian core apoptotic pathways**



**Figure 2.8. The anti-apoptotic activity of BCL-2, BCL-X<sub>L</sub> and MCL-1 against various death stimuli is differentially regulated by specific inactivator BH3-only**

**Table 2.1. Summary of differential regulation of the anti-apoptotic activity of BCL-2, BCL-X<sub>L</sub> and MCL-1 against BH3s by various inactivator BH3s**

### *Supplementary figure legends*

#### **Figure S2.1. Expression level of BH3-only molecules**

(A) Autoradiogram of BH3-only proteins translated *in vitro* in the presence of  $^{35}\text{S}$ -methionine. The quantity of each protein was determined by densitometry (FUJI, ImageGauge) then divided by the number of methionine in each protein.

(B) Autoradiogram of *in vitro* targeting of indicated BH3-only proteins to mitochondria. P denotes mitochondrial pellet; S, mitochondrial supernatant.

(C) Anti-HA Western blot of indicated HA-tagged BH3-only molecules transduced in *Bax/Bak* DKO cells by retrovirus. Asterisk indicates a cross-reactive band, serving as a loading control.

(D) Wild-type MEFs were infected with retrovirus expressing indicated HA-tagged BH3-only molecules. Death is presented as mean  $\pm$  s.d. of Annexin-V positive cells at 24 hrs from three independent experiments.

(E) Mitochondria isolated from p53 null MEFs were incubated with IVTT wild-type or mutant PUMA or truncated BID proteins, and cytochrome *c* release was quantitated by ELISA assays. Values shown are mean  $\pm$  s.d. of three independent experiments.

#### **Figure S2.2. Co-immunoprecipitation of BAX/BAK mutants**

(A) Wild-type MEFs or *Bax/ Bak* DKO MEFs reconstituted with mutant BAK (I82A & N83A) were lysed in 0.2 % NP40-lysis buffer, immunoprecipitated with anti-BCL-1 antibody, and analyzed by anti-BAK or anti-BCL-2 Western blots.

(B) Anti-BAX and anti-BAK Western blots of wild-type MEFs or *Bax*, *Bak* DKO MEFs reconstituted with either mutant BAX (L70A & D71A) or BAK (I82A & N83A) before or after treatment with staurosporine (STS) for 6 hours or etoposide for 12 hours.

(C) Wild-type or mutant BAK (I82A & N83A) was transiently co-expressed with HA-tagged VDAC2 in *Bax/Bak* DKO MEFs. Cells lysed in 1 % CHAPS lysis buffer were immunoprecipitated with anti-HA antibody and analyzed by anti-BAK or anti-VDAC2 Western blots.

(D) Wild-type MEFs or *Bax/Bak* DKO MEFs were treated with 10 mM BMH or DSS crosslinker and analyzed by anti-BCL-X<sub>L</sub> (upper panel) or anti-MCL-1 (lower panel) Western blots. No discernable differences following cross-linking were observed between BCL-X<sub>L</sub>/MCL-1 and BAX/BAK. Asterisks denote cross-reactive bands.

(E) Wild-type MEFs or *Bax/Bak* DKO MEFs reconstituted with mutant BAX (L70A & D71A) were lysed in 0.2 % NP-40 lysis buffer and analyzed by anti-BAX or anti-BCL-2 Western blots.

(F) MEFs or *Bax/Bak* DKO MEFs reconstituted with either mutant BAX (L70A & D71A) or BAK (I82A & N83A) were transduced with control retrovirus (MSCV) or retrovirus expressing BCL-2, then treated with 1  $\mu$ M STS to induce apoptosis. Death is presented by mean  $\pm$  s.d. of Annexin-V positive cells at 24 hrs from three independent experiments.

### **Figure S2.3. Cell viability of various MEFs**

(A) Wild-type MEFs or MEFs stably expressing BCL-2-IRES-PUMA were transduced with indicated BH3-only molecules by retrovirus. Death is presented by mean  $\pm$  s.d. of Annexin-V positive cells at 24 hrs from three independent experiments.

(B) Wild-type MEFs or MEFs stably expressing MCL-1, or MCL-1 and BAD, MCL-1 and NOXA, MCL-1 and BMF, or MCL-1 and BLK were transduced with retrovirus expressing truncated BID. Death is presented by mean  $\pm$  s.d. of Annexin-V positive cells at 24 hrs from three independent experiments.

(C) *Puma*<sup>+/-</sup>, *Puma*<sup>-/-</sup> MEFs, or *Puma*<sup>-/-</sup> MEFs stably expressing shRNA against *Bim* using pSuper-Retro system were transduced with control MSCV retrovirus or PUMA expressing retrovirus. Death is presented by mean  $\pm$  s.d. of Annexin-V positive cells at 24 hrs from three independent experiments.

(D) Anti-BIM Western blot of *Puma*<sup>-/-</sup> MEFs stably expressing shRNA against *Bim*

(E) SV-40 transformed *Apaf-1*<sup>-/-</sup> MEFs with or without etoposide (10  $\mu$ g/mL) and MG132 (10  $\mu$ M) treatment for 18 hours were lysed in 0.2 % NP-40 lysis buffer, immunoprecipitated with anti-MCL-1 antibody, and analyzed by anti-MCL-1, and-NOXA, or anti-BIM Western blots.

#### **Figure S2.4. BCL-2 family expression and interactions**

(A) Anti-BCL-2, anti-BCL-X<sub>L</sub>, anti-HA, anti-BAD, anti-BMF, and anti-NOXA Western blots of indicated cell lines used for viability assays shown in Fig. 2.8

(B) N-terminal HA-tagged MCL-1 was co-translated with BMF or NOXA *in vitro* in the presence of <sup>35</sup>S-methionine. IVTT proteins of BMF and NOXA alone served as negative controls. Reticulocytes in 0.2 % NP-40 lysis buffer were immunoprecipitated with anti-HA antibody and analyzed in 10 % NuPAGE gels and autoradiography.

## 2.7. Figures and tables

Figure 2.1

**A**

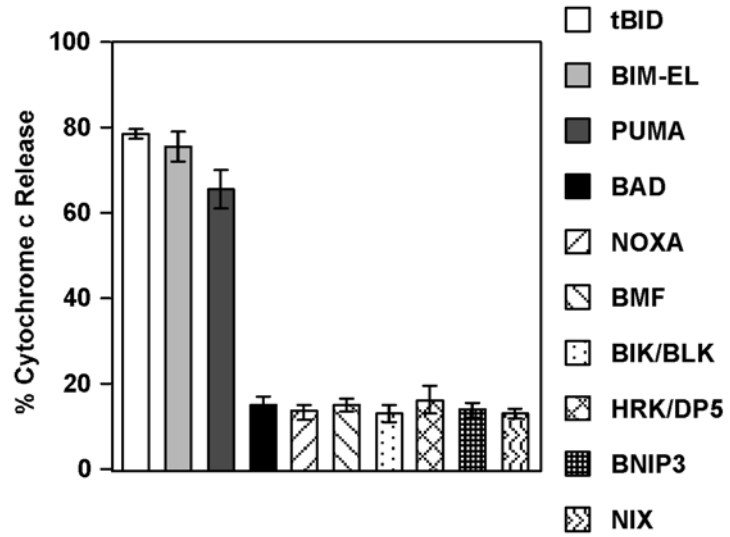

**B**

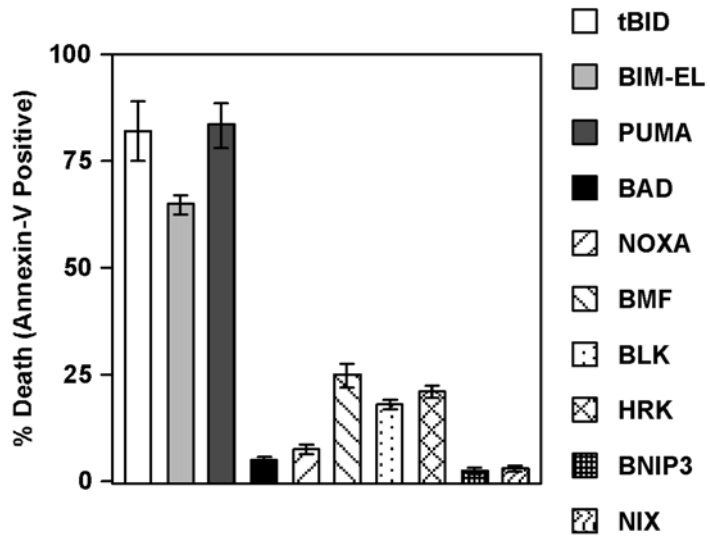

Courtesy of E. Cheng

Figure 2.1

C

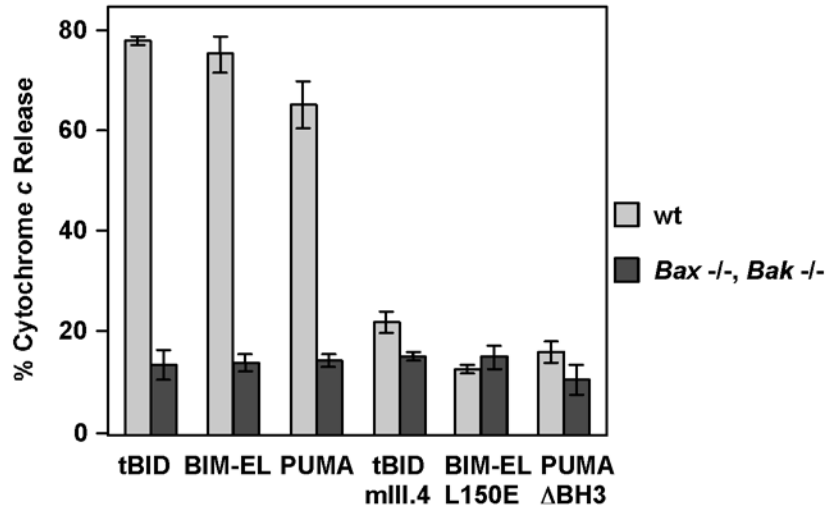

D

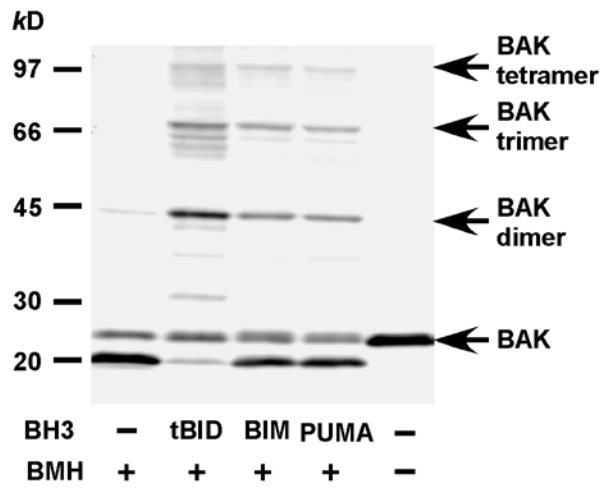

Courtesy of E. Cheng

Figure 2.1

**E**

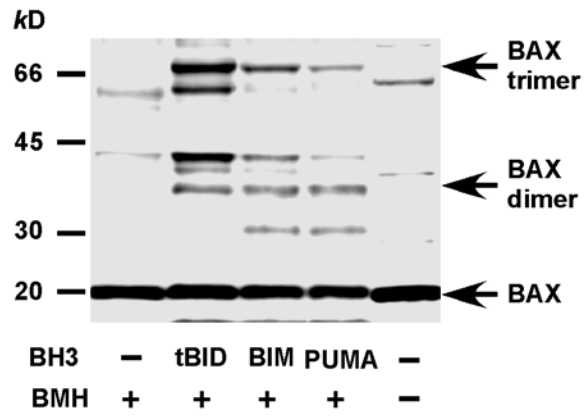

**F**

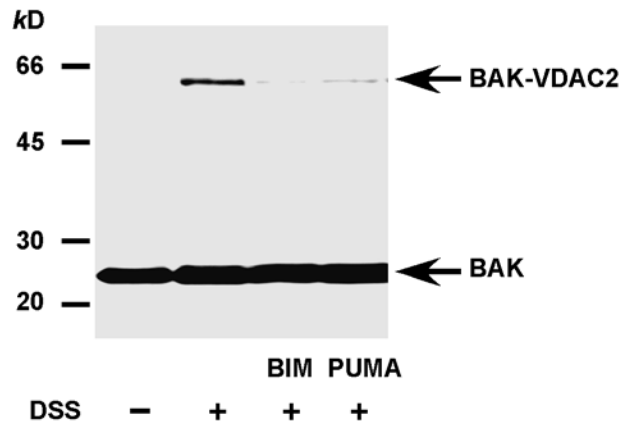

Courtesy of E. Cheng

Figure 2.2

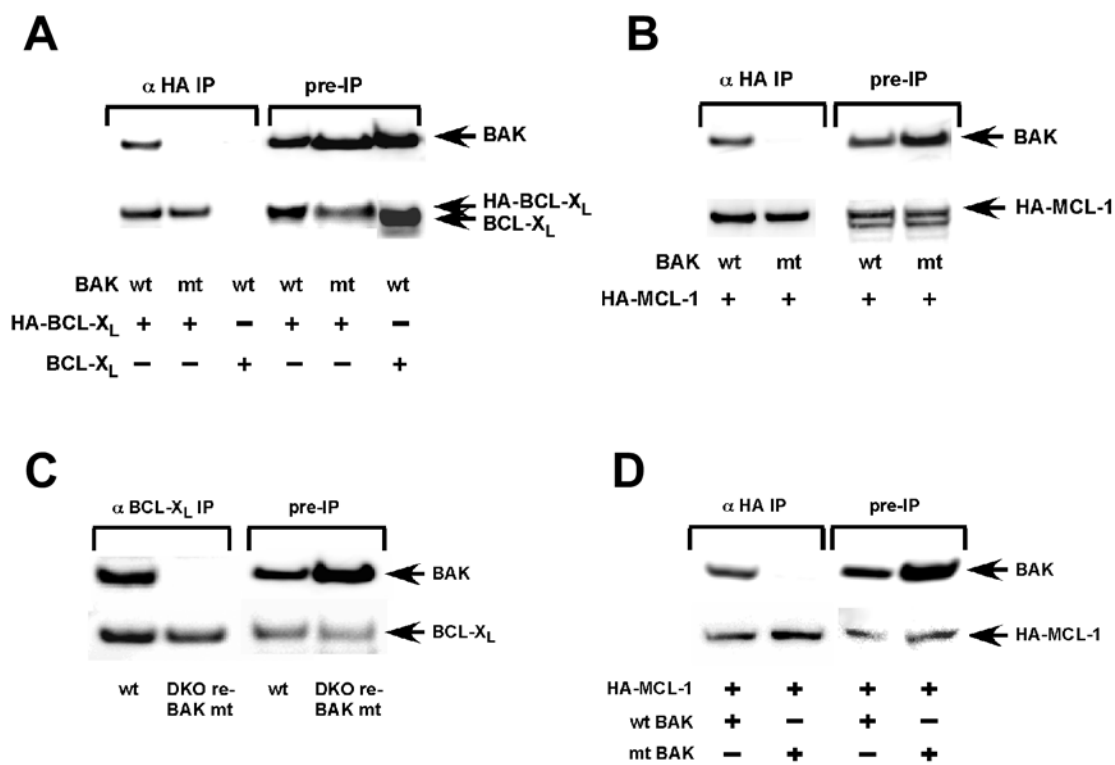
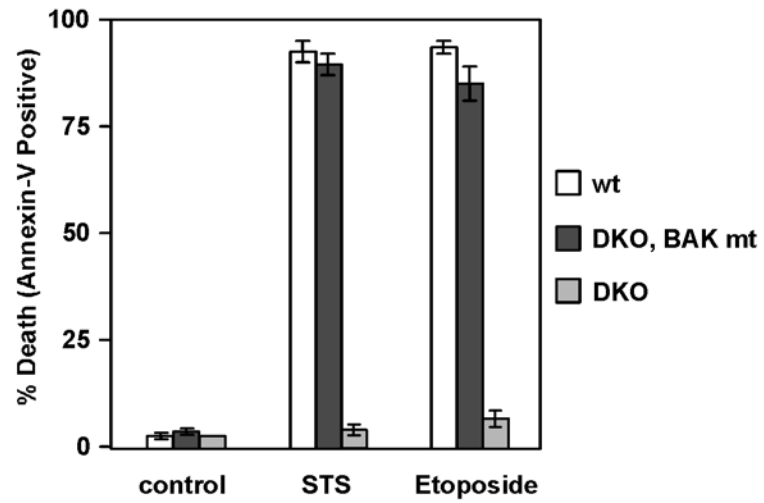



Figure 2.2

**E**



**F**

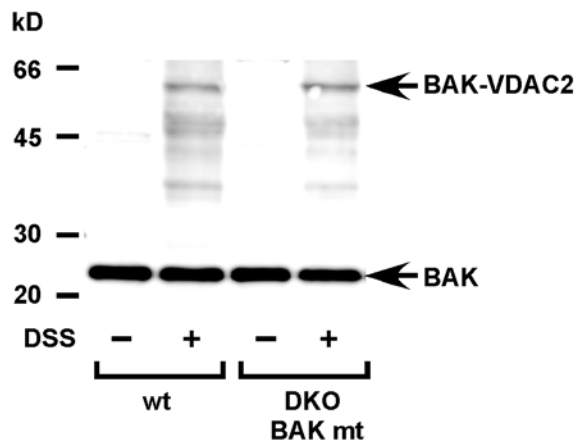

Fig. 2.2F: Courtesy of E. Cheng

Figure 2.3

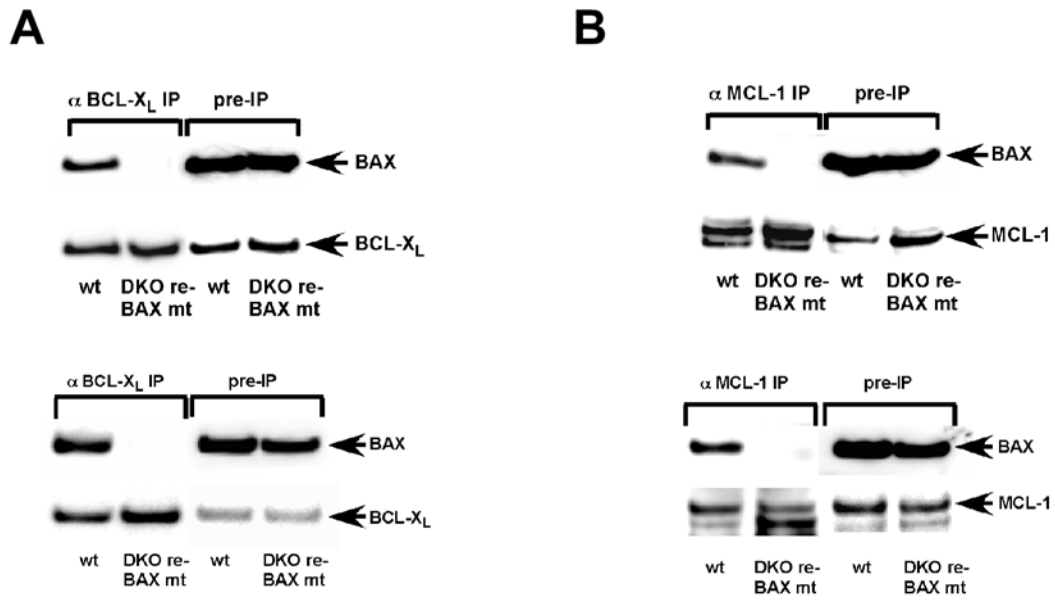
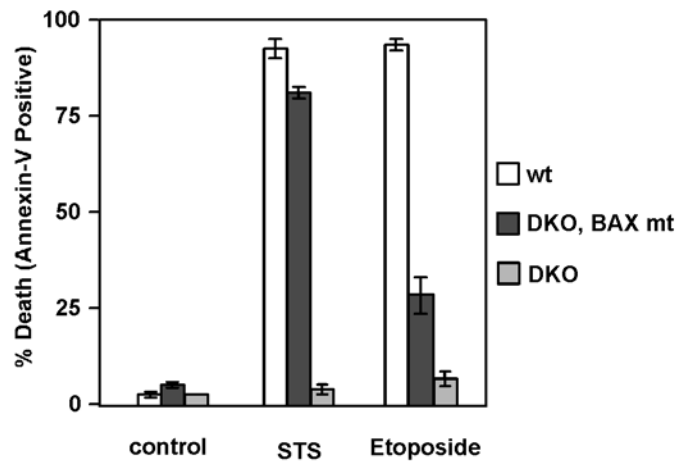
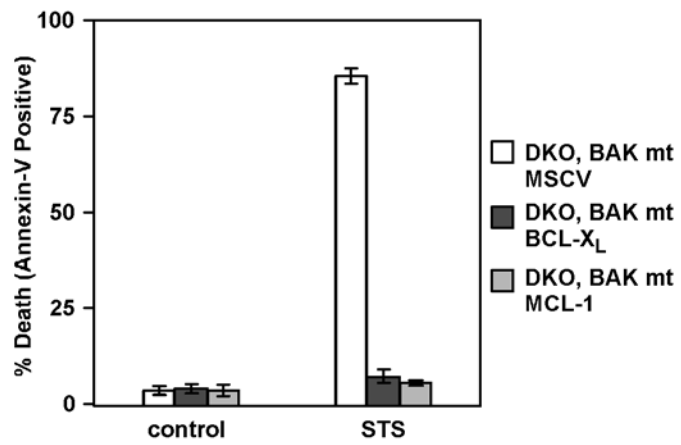

Figure 2.3

C



D



F

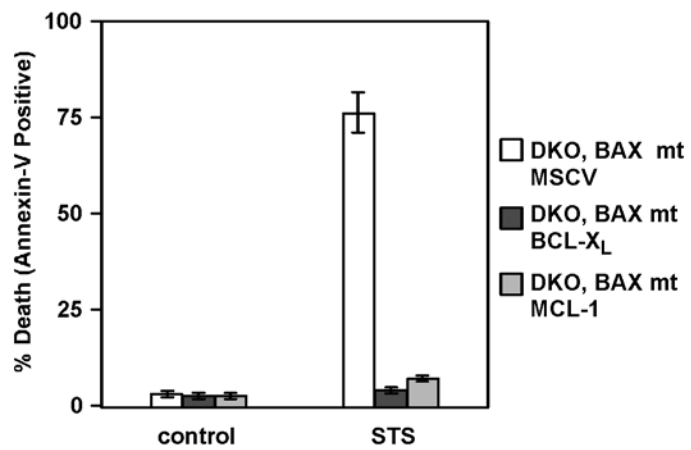

Fig. 2D & F: Courtesy of M. Rafiuddin-Shah

Figure 2.4

**A**

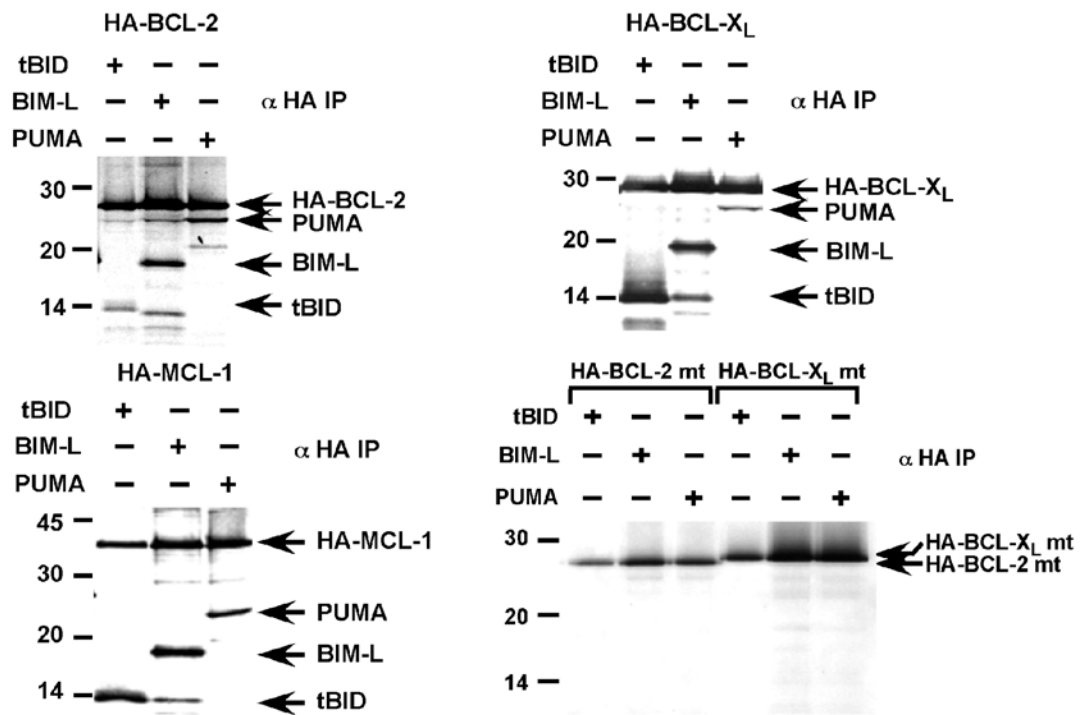
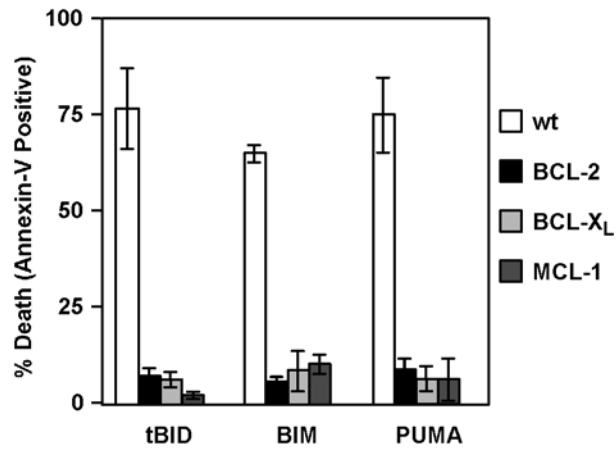
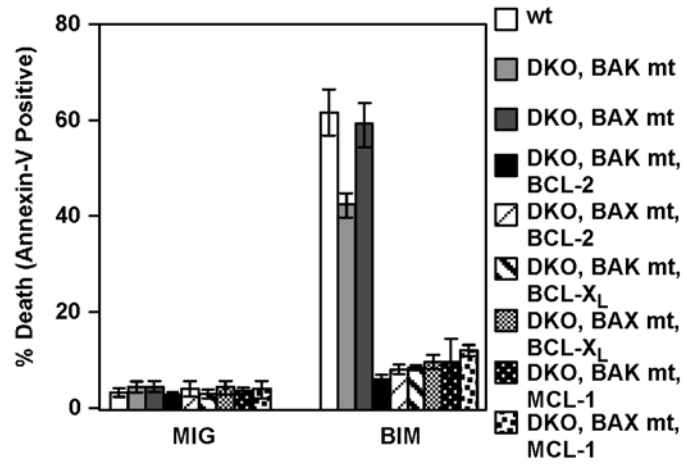

Figure 2.4

**B**



**C**



Courtesy of M. Rafiuddin-Shah

Figure 2.4

**D**

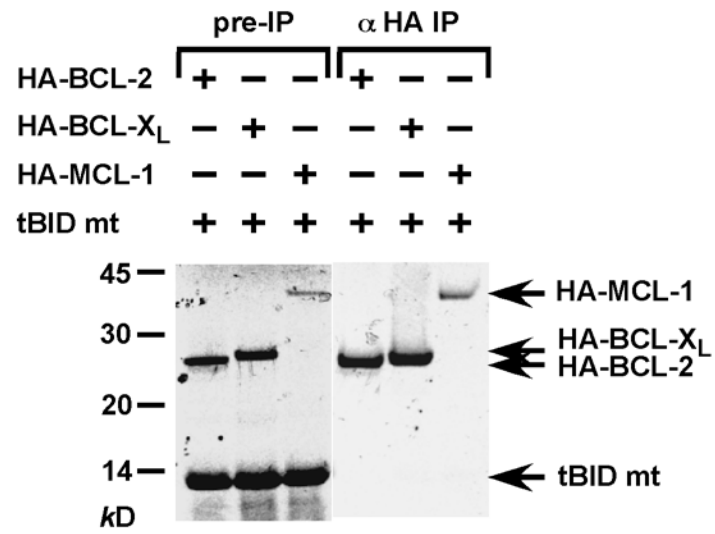

**E**

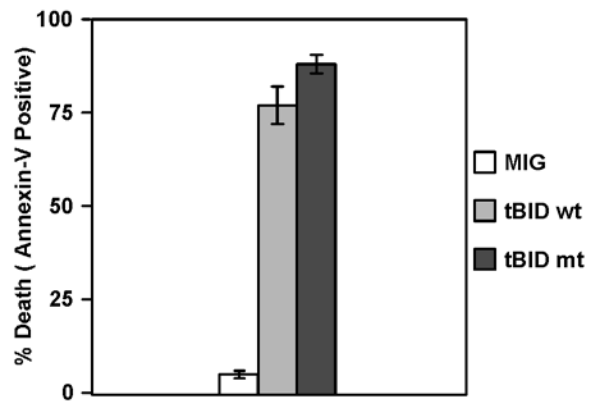
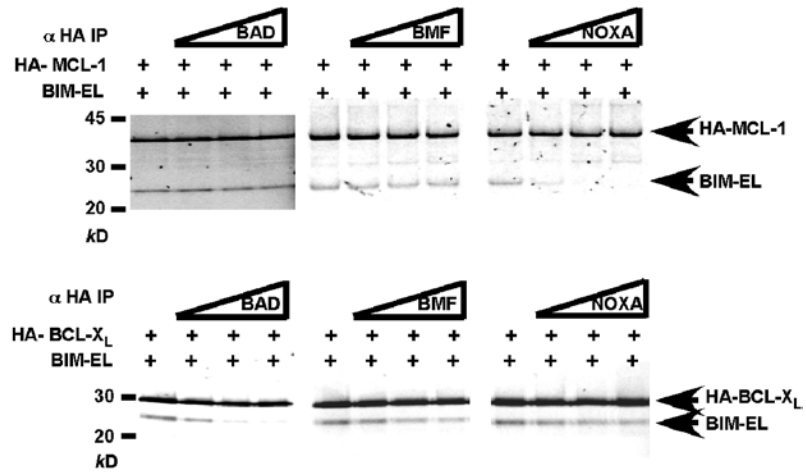

Fig. 2.4E: Courtesy of M. Rafiuddin-Shah

Figure 2.5

**A**



**B**

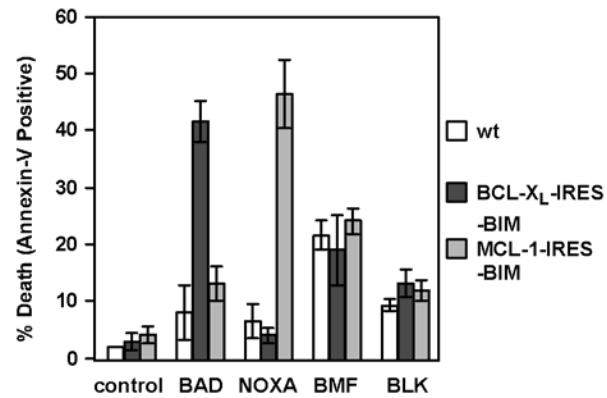
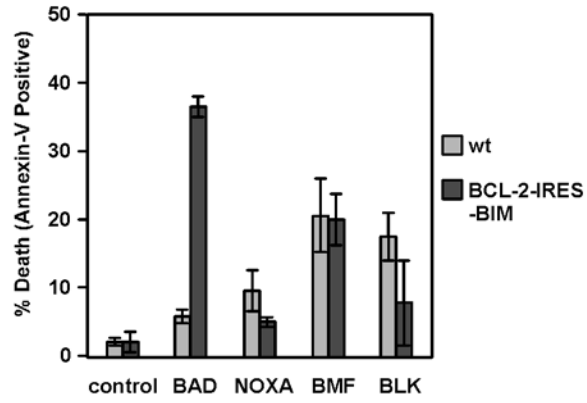

Fig. 2.5B: Courtesy of M. Rafiuddin-Shah

Figure 2.5

C



D

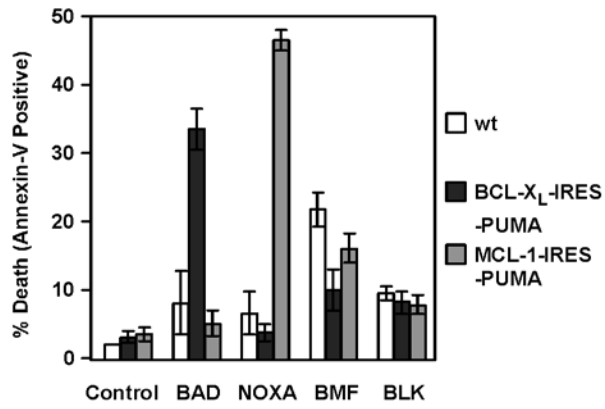

E

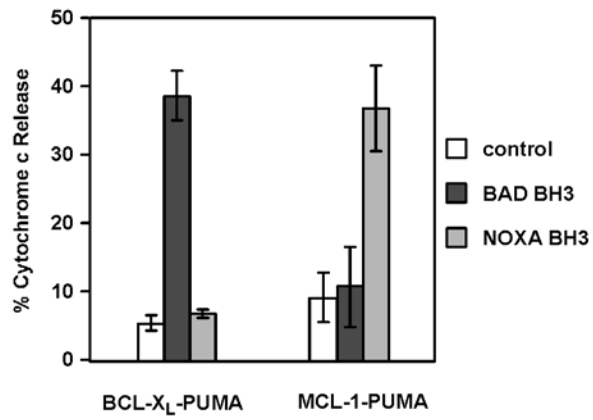
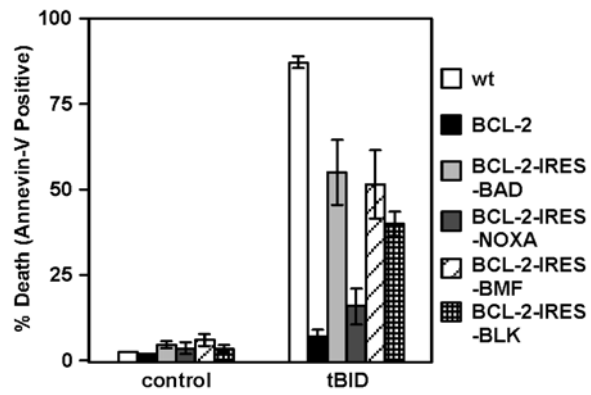

Fig. 2.5C & D: Courtesy of M. Rafiuddin-Shah

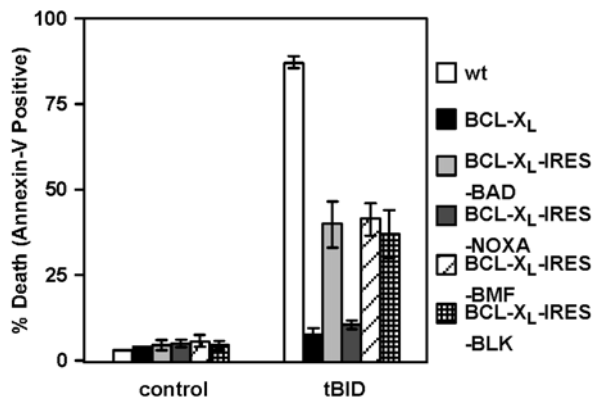

Figure 2.5

F



G



H

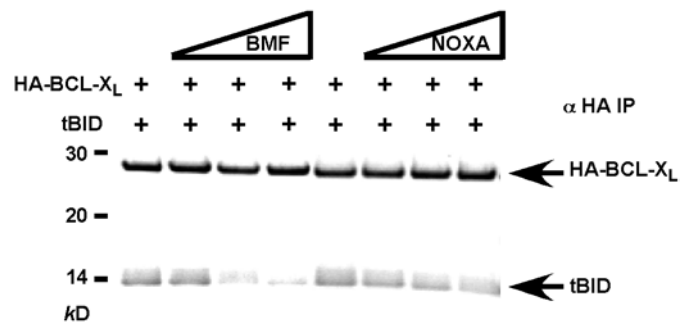
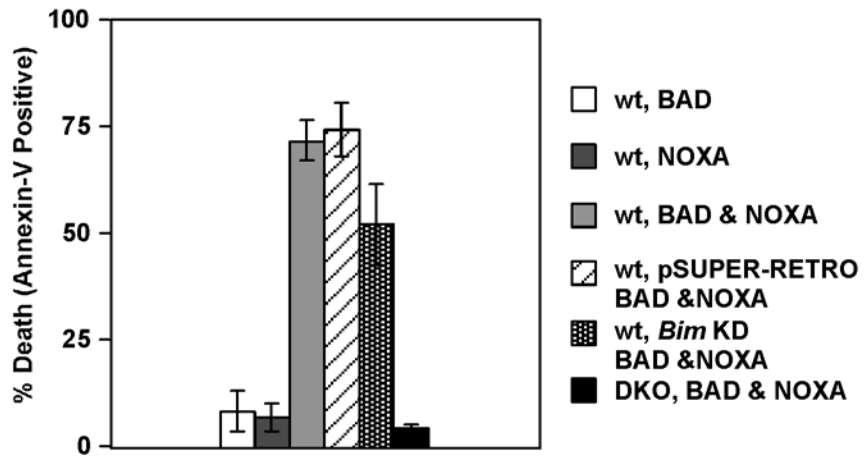

Fig. 2.5F & G: Courtesy of M. Rafiuddin-Shah

Figure 2.6

**A**



**B**

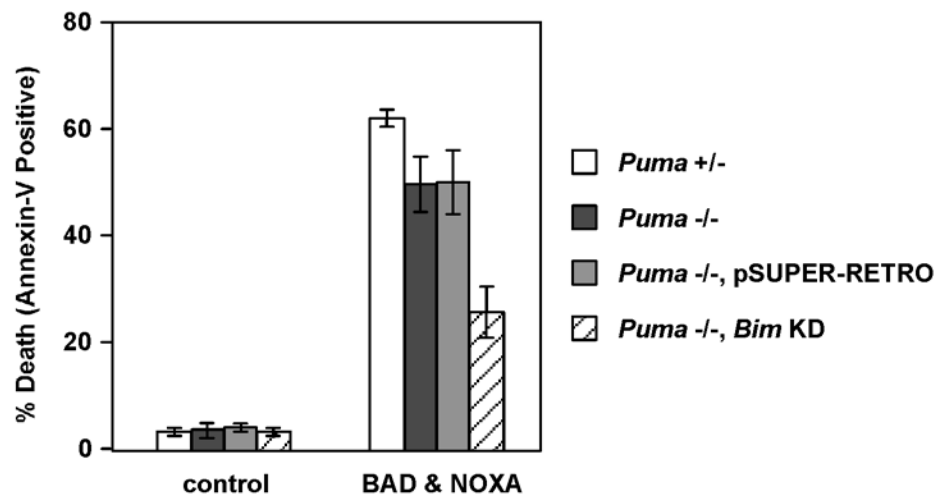

Courtesy of M. Rafiuddin-Shah

Figure 2.7

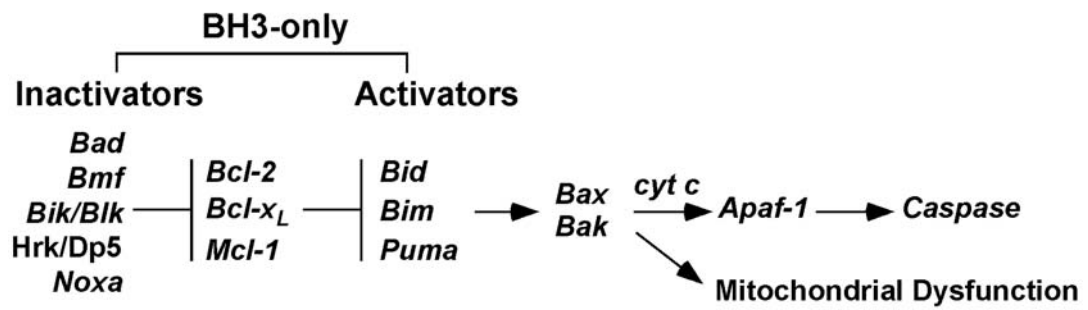
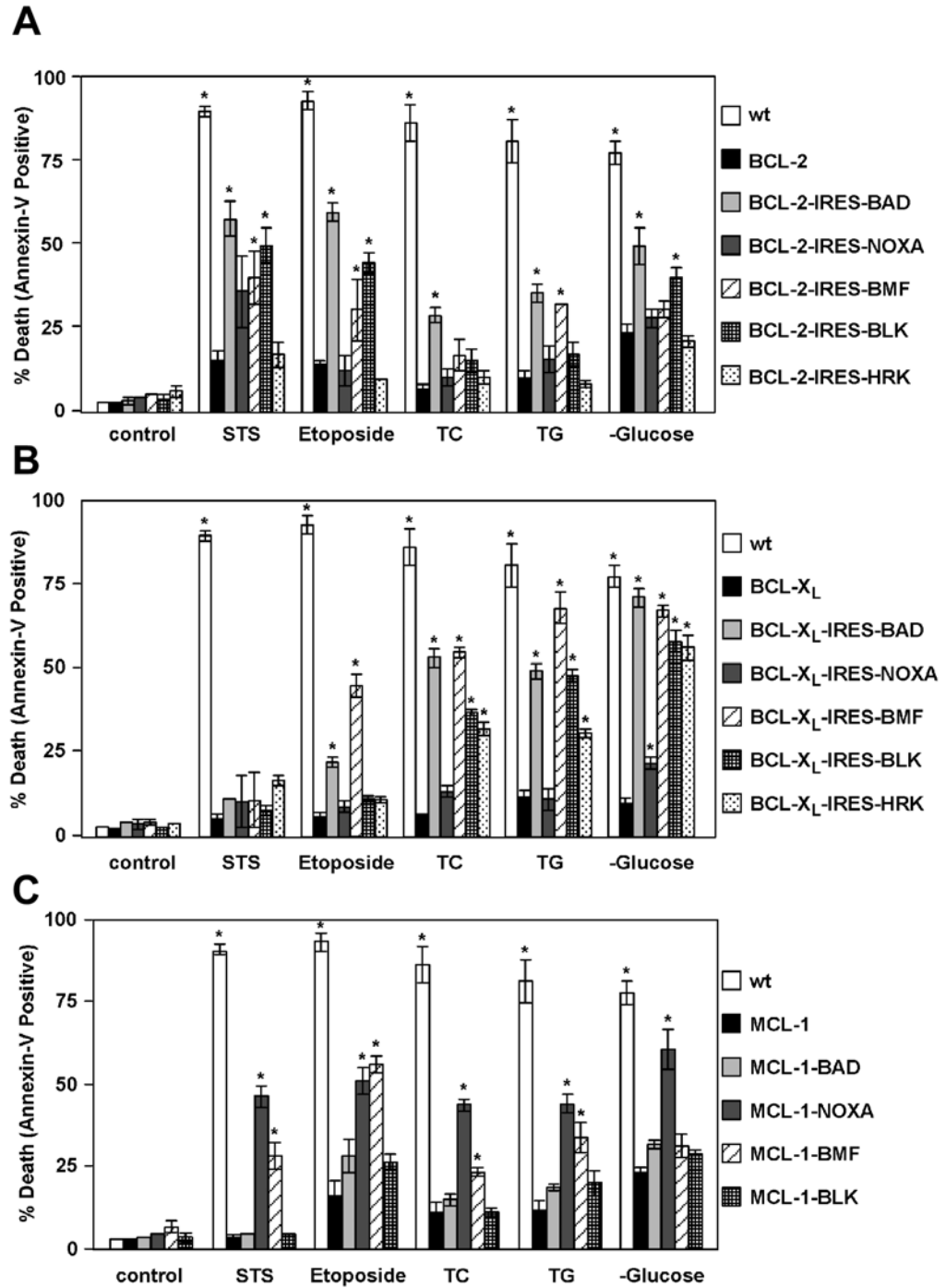

Figure 2.8



Courtesy of M. Rafiuddin-Shah

**Table 2.1**

Inactivator BH3-only Anti-apoptotic	—	BAD	NOXA	BMF	BIK/BLK	Activator BH3-only
BCL-2/BCL-X <sub>L</sub>	S	D	S	D	D	BID
BCL-2/BCL-X <sub>L</sub>	S	D	S	S	S	BIM
BCL-2/BCL-X <sub>L</sub>	S	D	S	S	S	PUMA
MCL-1	S	S	D	S	S	BID
MCL-1	S	S	D	S	S	BIM
MCL-1	S	S	D	S	S	PUMA

Figure S2.1

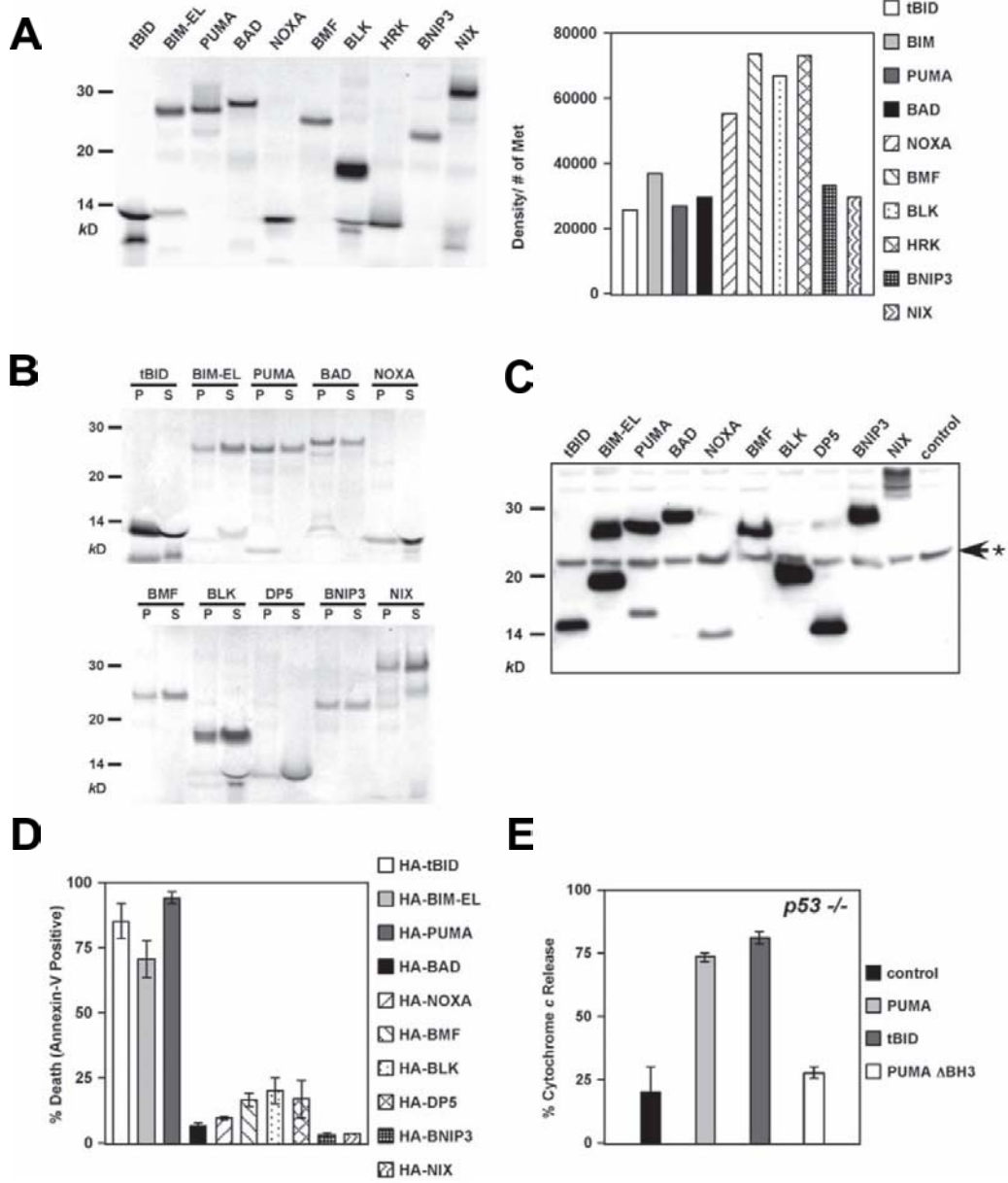

Fig. S2.1D: Courtesy of M. Rafiuddin-Shah

Figure S2.2

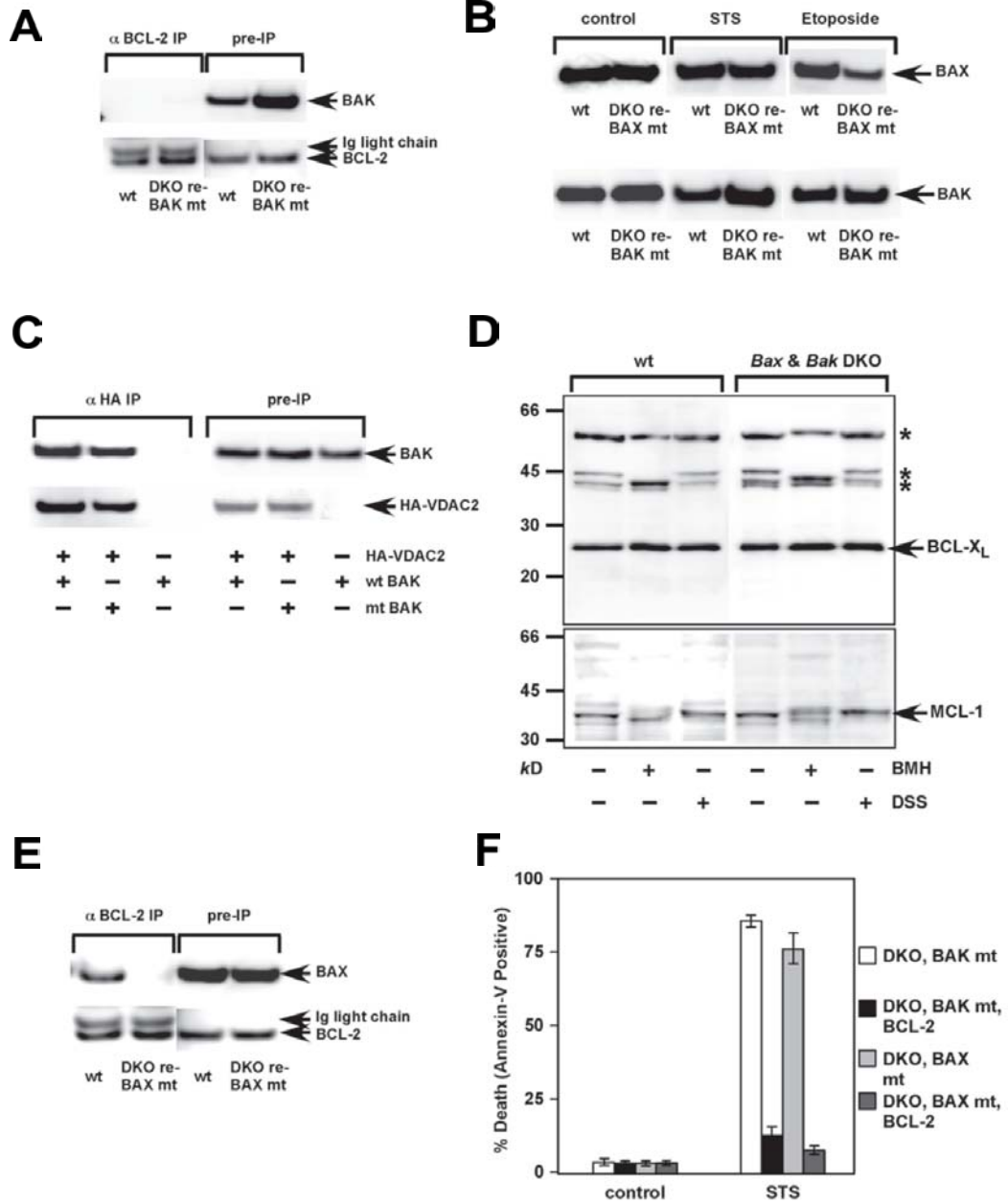

Fig. S2.2F: Courtesy of M. Rafiuddin-Shah

Figure S2.3

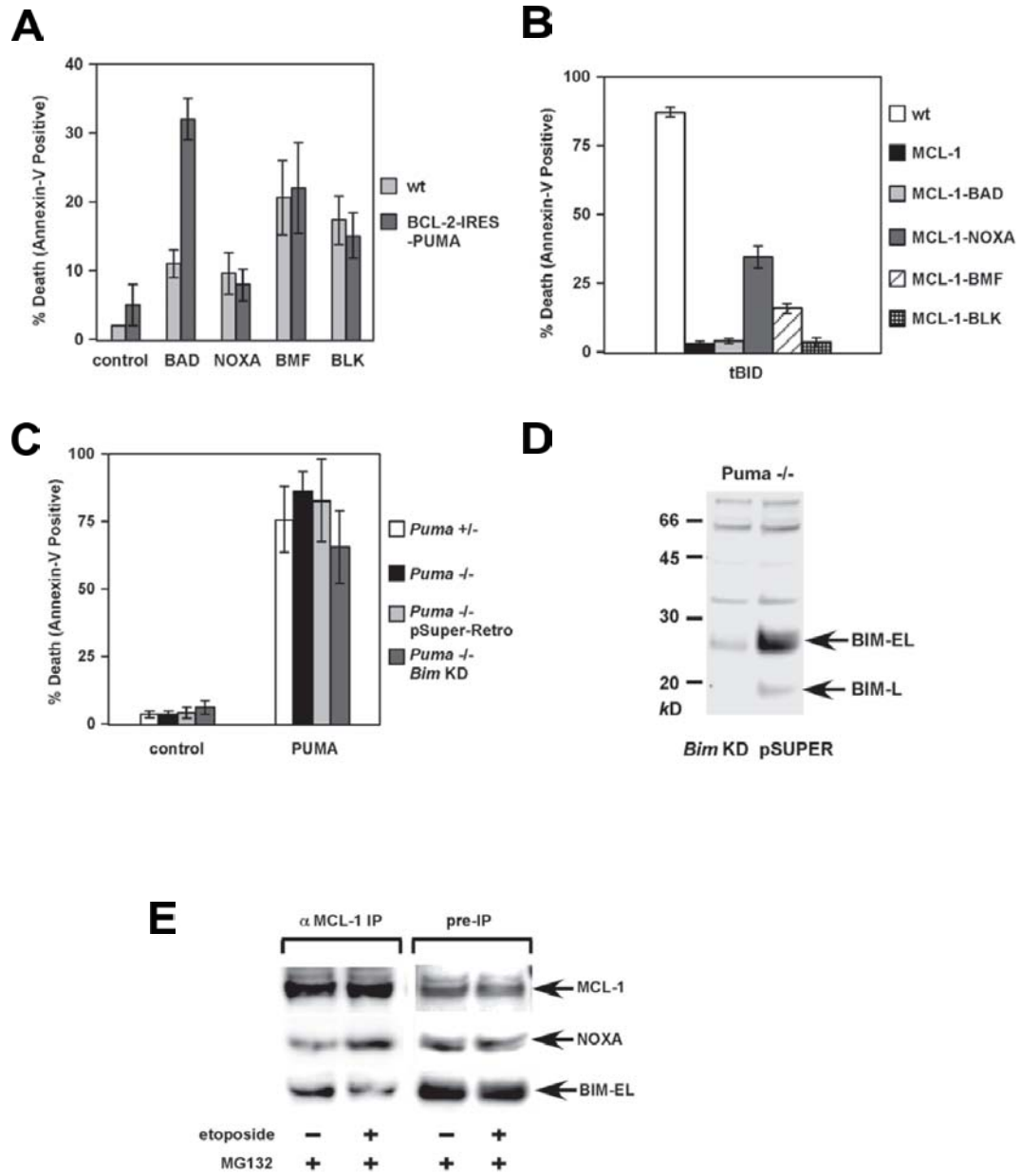
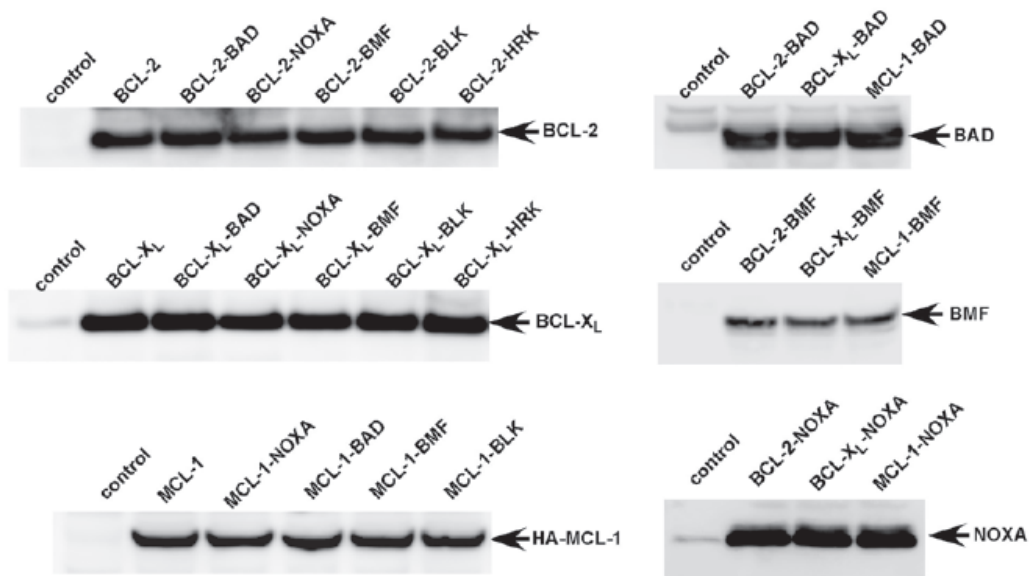

Fig. S2.3A, B, & C: Courtesy of M. Rafiuddin-Shah



Figure S2.4

**A**



**B**

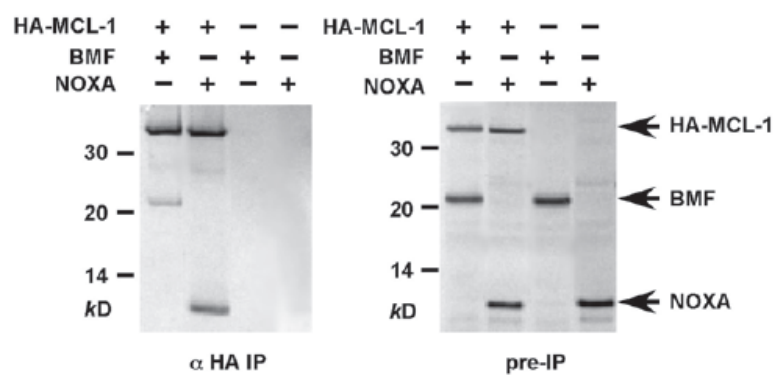

Fig. S2.4A: Courtesy of M. Rafiuddin-Shah

**- CHAPTER 3 -**

**Stepwise Activation of BAX and BAK by tBID, BIM, and PUMA  
Initiates Mitochondrial Apoptosis**

(The content of this chapter is being published as Kim et al., (2009) Mol. Cell. *In press*)

### 3.1. Summary

While activation of BAX/BAK by BH3-only molecules (BH3s) is essential for mitochondrial apoptosis, the underlying mechanisms remain unsettled. Here, we demonstrate that BAX undergoes stepwise structural reorganization leading to mitochondrial targeting and homo-oligomerization. The  $\alpha 1$  helix of BAX keeps the  $\alpha 9$  helix engaged in the dimerization pocket, rendering BAX as a monomer in cytosol. The ‘activator’ BH3s, tBID, BIM, and PUMA attack and expose the  $\alpha 1$  helix of BAX, resulting in secondary disengagement of the  $\alpha 9$  helix and thereby mitochondrial insertion. Activated BH3s remain associated with the N-terminally exposed BAX through the BH1 domain to drive homo-oligomerization. BAK, an integral mitochondrial membrane protein, has bypassed the first activation step, explaining its faster killing kinetics than BAX. Furthermore, death signals initiated at ER induce BIM and PUMA to activate mitochondrial apoptosis. Accordingly, deficiency of *Bim* and *Puma* impedes ER stress-induced BAX/BAK activation and apoptosis. Our study provides novel mechanistic insights regarding the spatiotemporal execution of BAX/BAK-governed cell death.

### 3.2. Introduction

Mammalian cell death proceeds through a highly regulated genetic program termed apoptosis that is heavily dependent on the mitochondria (Danial and Korsmeyer, 2004). Multiple apoptotic signals culminate in permeabilizing the mitochondrial outer membrane (MOM), resulting in the release of apoptogenic factors including cytochrome *c* and SMAC (Wang, 2001). Once released, cytochrome *c* activates Apaf-1 to assist the morphological and biochemical changes associated with apoptosis. The permeabilization of the MOM not only couples the mitochondria to the activation of caspases but also initiates caspase-independent mitochondrial dysfunction (Cheng et al., 2001). The BCL-2 family proteins control a crucial checkpoint of apoptosis at the mitochondria (Cory and Adams, 2002; Korsmeyer et al., 2000). Multidomain proapoptotic BAX and BAK are essential effectors responsible for the permeabilization of the MOM, whereas anti-apoptotic BCL-2, BCL-X<sub>L</sub>, and MCL-1 preserve mitochondrial integrity and prevent cytochrome *c* efflux triggered by apoptotic stimuli. The third BCL-2 subfamily of proteins, BH3-only proteins (BH3s), promotes apoptosis by either activating BAX/BAK or inactivating BCL-2/BCL-X<sub>L</sub>/MCL-1 (Certo et al., 2006; Cheng et al., 2001; Kim et al., 2006; Kuwana et al., 2005; Letai et al., 2002; Wei et al., 2000; Wei et al., 2001). Upon apoptosis, the ‘activator’ BH3s, including truncated BID (tBID), BIM, and PUMA, activate BAX and BAK to mediate cytochrome *c* efflux, leading to caspase activation (Cheng et al., 2001; Desagher et al., 1999, Kim et al., 2006; Wei et al., 2002; Wei et al., 2001). Conversely, the anti-apoptotic BCL-2, BCL-X<sub>L</sub>, and MCL-1 sequester ‘activator’ BH3s into inert complexes, thus preventing BAX/BAK activation (Cheng et al., 2001;

Kim et al., 2006). The remaining BH3s including BAD, NOXA, BMF, HRK, and BIK/BLK do not activate BAX/BAK directly, but instead prevent the anti-apoptotic BCL-2 members from sequestering the 'activator' BH3s (Certo et al., 2006; Kim et al., 2006; Kuwana et al., 2005; Letai et al., 2002). Although it was proposed that activation of BAX and BAK occurred by default as long as all the anti-apoptotic BCL-2 proteins were neutralized by BH3s (Willis et al., 2007), the liposome studies clearly recapitulate the direct activation model in which tBID protein or BH3 domain peptides derived from BID or BIM induced BAX oligomerization and membrane permeabilization (Gavathiotis et al., 2008; Kuwana et al., 2002; Walensky et al., 2006b). In addition the temporal sequence of BAX activation by tBID was nicely demonstrated by a FRET (fluorescence resonance energy transfer)-based liposomal study (Lovell et al., 2008).

While BAX and BAK are the essential effectors of mitochondrial apoptosis, their proapoptotic activity is tightly kept in check (Cheng et al., 2003; Lindsten et al., 2000; Wei et al., 2001). BAX exists in the cytosol as a monomer with its C-terminal  $\alpha 9$  helix occupying the dimerization pocket formed by BH1-3 domains (Suzuki et al., 2000). This auto-inhibited BAX monomer may be further stabilized by associated proteins (Reed, 2006). By contrast, the C-terminal  $\alpha 9$  helix of BAK is constitutively inserted in the MOM and its activity is inhibited by mammalian-restricted VDAC isoform, VDAC2, which occupies the dimerization pocket of BAK to restrict BAK in the monomeric inactive conformation (Cheng et al., 2003; Wei et al., 2000). Upon apoptosis, 'activator' BH3s induce conformational changes of BAX to promote the targeting and homo-oligomerization of BAX at the MOM, and disrupt BAK-VDAC2 interaction to enable homo-oligomerization of BAK, leading to the efflux of apoptogenic factors (Cheng et al.,

2003; Desagher et al., 1999; Kim et al., 2006; Wei et al., 2000) Therefore, the proapoptotic activity of BAX and BAK is triggered by BH3s, whose activity is in turn regulated either transcriptionally or posttranslationally by upstream death signaling cascade (Danial and Korsmeyer, 2004; Korsmeyer, 2000). By analogy, BH3s function as death ligands that allosterically regulate the mitochondrial death receptor BAX/BAK (Korsmeyer, 2000).

Conformational changes and homo-oligomerization are two critical events associated with the activation of BAX/BAK by BH3s (Korsmeyer, 2000; Reed, 2006). However, the underlying mechanisms remain unsettled. It is especially complex for BAX due to its change in the subcellular localization during apoptosis (Wolter et al., 1997). The N-terminal exposure of BAX is a commonly used marker for its activation of which the molecular basis is obscure (Desagher et al., 1999; Nechushtan et al., 1999). Although it was proposed that the intramolecular interaction between the N- and C- terminal regions of BAX might somehow regulate its activation (Goping et al., 1998; Nechushtan et al., 1999; Schinzel et al., 2004), direct experimental data supporting this model is missing. Interestingly, our recent study demonstrated that a novel interaction site involving the  $\alpha 1$  and  $\alpha 6$  helices of BAX and the BH3 domain of BIM is required for BAX activation (Gavathiotis et al., 2008). The  $\alpha 1$  helix of BAX was also implicated in its interaction with BID and PUMA (Catron et al., 2004). However, it is unknown how this interaction contributes to BAX activation. BAK was reported to expose its BH3 domain to form dimers via BH3-groove interactions (Dewson et al., 2008). Unfortunately, this study did not examine higher-ordered BAK oligomers that are more functionally relevant since BAX tetramers but not dimers could form pores large enough for cytochrome *c*

passage (Saito et al., 2000). To address these questions, we performed structural functional analyses to dissect the molecular mechanisms by which BH3s activate BAX/BAK. We demonstrated that activation of BAX can be dissected into two sequential steps, mitochondrial targeting and homo-oligomerization, both of which require ‘activator’ BH3s and intact BH1 and BH3 domains of BAX. The  $\alpha 1$  helix of BAX stabilizes the binding of the  $\alpha 9$  helix to dimerization pocket, which in turn controls the mitochondrial targeting of BAX. Thus, tBID, BIM, and PUMA initiates the activation process of BAX by attacking the  $\alpha 1$  helix, resulting in the N-terminal exposure of BAX and secondary disengagement of the  $\alpha 9$  helix that becomes available for mitochondrial targeting. tBID, BIM, and PUMA remain associated the N-terminally exposed BAX to drive homo-oligomerization of mitochondrially localized BAX. Our data reveal a dynamic interaction between BH3s and BAX, which helps explain the previous difficulty in detecting these interactions. BAK, an integral mitochondrial membrane protein, has bypassed the first activation step but still requires ‘activator’ BH3s to induce its homo-oligomerization. The BH1 and BH3 domains are required for the assembly of higher-ordered BAX or BAK oligomers, which is essential for the proapoptotic activity of BAX or BAK. Moreover, ER stress induces BIM and PUMA to activate BAX/BAK at the mitochondria, exemplifying how ‘activator’ BH3s interconnect upstream death signaling cascades with downstream BAX/BAK-dependent mitochondrial death program. All together, our study supports the direct engagement of ‘activator’ BH3s in activating BAX/BAK-dependent mitochondrial death program.

### **3.3. Materials and Methods**

#### **Plasmid construction and retrovirus production**

Indicated *Bcl-2* members were cloned into pSG5 (Stratagene), pcDNA3 (Invitrogen), or the retroviral expression vector MSCV-IRES-GFP (pMIG) or MSCV-puro (Clontech). Mutant *Bax* and *Bak* were generated by PCR-based site-directed mutagenesis. All the constructs were confirmed by DNA sequencing. The production of retrovirus was described previously (Cheng et al., 2001).

#### **Antibody and reagents**

Antibodies used for immunoblots are listed as followed: anti-BAK (NT, Upstate), anti-BAK (G23, Santa Cruz), anti-BAX (N-20, Santa Cruz), anti-BAX (6A7, Trevigen), anti-BIM (Calbiochem), anti-PUMA (Sigma), anti-HA (12CA5), and anti-BCL-2 (3F11, BD Bioscience). The chemicals with concentration used are as followed: etoposide 10 µg/mL, staurosporine 1.2 µM, tunicamycin 1 µg/mL, thapsigargin 2 µM; and bismaleimido-hexane (BMH) 5 mM (Pierce).

#### **Cell culture and viability assay**

All the MEFs utilized were SV40-transformed. Reconstitution of BAX or BAK into DKO cell was achieved by retroviral transduction of BAX-IRES-GFP or BAK-IRES-GFP, followed by MoFlo (DakoCytomation) sorting for GFP-positive cells. Cell death was quantified by Annexin-V-Cy3 (Biovision) and CellQuest Pro software. *P* values for statistical analyses were obtained using Student's *t* test.



## **Mitochondria isolation, alkaline extraction of BAX, protein cross-linking, and gel filtration chromatography**

Mitochondria isolation and cross-linking of BAX were performed as described previously (Cheng et al., 2001; Kim et al., 2006). The chromatographic step of Superdex 200 (HR 10/30, GE-Amersham) was performed on an automatic fast protein liquid chromatography (AKTApurifier, GE-Amersham). The column was equilibrated with 2 % CHAPS buffer (2 % CHAPS, 300 mM NaCl, 0.2 mM DTT, 20 mM HEPES pH 7.5) and calibrated with thyroglobulin (669 kD, GE-Amersham), ferritin (440 kD, GE-Amersham), catalase (232 kD, GE-Amersham), aldolase (158 kD, GE-Amersham), bovine serum albumin (66 kD, Calbiochem), and cytochrome *c* (14 kD, Sigma). Protein lysates (200 µg) were loaded onto the column, eluted at a flow rate of 0.3 ml/min. Fractions of 0.6 ml were collected, precipitated by trichloroacetic acid, and analyzed by 8 – 16 % SDS-PAGE (Bio-Rad). For alkaline extraction, mitochondria were resuspended in 0.1 M Na<sub>2</sub>CO<sub>3</sub> (pH 11.5) for 30 min on ice. Supernatant (alkali-sensitive) and pellet (alkali-resistant) fractions were separated by centrifugation at 75,000 rpm for 10 min at 4 °C.

## **Immunoblot analysis and immunoprecipitation**

Cell or mitochondrial lysates were resolved by NuPAGE (Invitrogen) gels and transferred onto PVDF (Immobilon-P, Millipore) followed by antibody detection using enhanced chemiluminescence method (Western Lightning, Perkin Elmer) and LAS-300 Imaging system (FUJIFILM Life Science). *In vitro* transcription and translation reactions were performed with TNT<sup>®</sup> T7 Quick Coupled Transcription/Translation Systems or Wheat Germ Extract System (Promega). Immunoprecipitation (IP) of IVTT proteins were described

previously (Kim et al., 2006). To detect BAX or BAK homo-dimers, IP was performed using 0.2% NP40 isotonic buffer (0.2 % NP40, 142.5 mM KCl, 5 mM MgCl<sub>2</sub>, 1 mM EGTA, 20 mM HEPES at pH 7.5). To detect intramolecular interaction of BAX, IP was performed using 1 % CHAPS buffer (1 % CHAPS, 142.5 mM KCl, 2 mM CaCl<sub>2</sub>, 20 mM Tris-Cl, pH 7.4). Anti-6A7 IP was performed using 1 % CHAPS buffer.

### **Fluorescence microscopy**

Fluorescence images were acquired with a SPOT camera (Diagnostics instruments) mounted on an Olympus IX51 microscope (Olympus).

### 3.4. Results

Previous mutagenesis studies of BAX and BAK often generate conflicting results due to overexpression of BAX/BAK mutants in cells containing wild-type (wt) BAK/BAK, which likely assess their function as BH3-like death ligands that could activate endogenous BAX/BAK (Chittenden, 1995; Simonen et al., 1997; Wang et al., 1998). To fully address the role of BAX and BAK as mitochondrial death receptors, we reconstituted mutants of BAX or BAK into *Bax/Bak* double knockout (DKO) mouse embryonic fibroblasts (MEFs) to a physiological level similar to wt cells and examined the ability of each mutant to restore the apoptotic sensitivity of death-resistance DKO cells (Fig. S3.1).

#### ***Mitochondrial targeting and homo-oligomerization are two separable, essential steps of BAX activation***

Although BAX contains a conserved, putative transmembrane domain at the C-terminal  $\alpha 9$  helix (Wolter et al., 1997), it was reported that its N-terminus also bears a mitochondrial targeting signals (Cartron et al., 2003). To determine whether the C-terminal transmembrane domain is required for the mitochondrial targeting and proapoptotic activity of BAX, GFP-BAX or GFP-BAX $\Delta$ C (BAX mutant with deletion of the C-terminal transmembrane domain) was reconstituted into DKO cells. In accordance with BAX, GFP-BAX restored the apoptotic sensitivity of DKO cells and translocated from cytosol to mitochondria in response to various intrinsic death signals (Fig. 3.1A, C and data not shown). On the contrary, GFP-BAX $\Delta$ C remained in the cytosol upon death

stimuli and BAX $\Delta$ C failed to induce apoptosis, supporting the essential role of  $\alpha$ 9 helix for both mitochondrial targeting and death induction (Fig. 3.1A, C).

The S184V mutation at the  $\alpha$ 9 helix of BAX constitutively targeted BAX to mitochondria, which is consistent with a previous report (Nechushtan et al., 1999) (Fig. 3.1B). Remarkably, BAX S184V did not spontaneously induce apoptosis in the absence of death signals (Fig. 3.1C). DKO cells reconstituted with BAX S184V did die faster than those expressing wt BAX (Fig. 3.1D), consistent with the notion that BAX S184V has bypassed the activation process required for mitochondrial targeting. This might help explain why *Bax*-deficient cells (BAK-dependent apoptosis) died faster than *Bak*-deficient cells (BAX-dependent apoptosis) (Fig. S3.2). Interestingly, L63E mutation at the BH3 domain also rendered BAX localized at the mitochondria, but it totally abolished the proapoptotic activity (Fig. 3.1B, C). To determine the molecular basis underlying the functional differences between these two mitochondria-targeted BAX mutants, we examined whether they differ in the ability to undergo conformational changes. The N-terminal BAX epitope recognized by the 6A7 antibody (aa residues 12-24) becomes exposed after an apoptotic stimulus (Hsu and Youle, 1997; Nechushtan et al., 1999). Thus, anti-6A7 antibody could only immunoprecipitate BAX from cells following DNA damage but not from viable cells using CHAPS buffer (Fig. 3.1E). It was reported that NP-40 and Triton-X 100 but not CHAPS could induce the conformational changes of BAX (Hsu and Youle, 1997). Surprisingly, both L63E and S184V mutants of BAX have already exposed their N-termini even in the absence of apoptotic stimuli (Fig. 3.1E). These data suggest that the N-terminal exposure indicates mitochondrial targeting but not full activation of BAX. We next performed gel filtration assays to assess the formation of

BAX homo-oligomers triggered by tBID. Like wt BAX, BAX S184V was eluted as a monomer (molecular weight ~20 kD) before activation and formed higher-ordered oligomers in response to tBID (Fig. 3.1F). By contrast, BAX L63E failed to undergo homo-oligomerization and was eluted around 50-60 kD range irrespective of tBID treatment (Fig. 3.1F). It is possible that BAX L63E formed dimer, or associated with other proteins or detergent micelles, which accounts for its elution at almost twice of its molecular weight. Nevertheless, these findings clearly demonstrate the importance of BH3 domain for the homo-oligomerization and thereby the proapoptotic activity of BAX.

***The N-terminal exposure of BAX correlates with mitochondrial targeting rather than homo-oligomerization***

To further investigate the importance of BAX homo-oligomerization, we performed extensive mutagenesis and identified two additional BAX mutants that failed to undergo homo-oligomerization. BH1 (G108E) and BH3 (G67R) domain mutants failed to form higher-ordered oligomers detected by gel filtration in response to tBID (Fig. 3.2A). In addition, HA-tagged BAX G67R or G108R was unable to co-precipitate non-tagged corresponding mutant by anti-HA immunoprecipitation (Fig. S3.3). Accordingly, these two mutants were unable to rescue the apoptotic defect of DKO cells (Fig. 3.2B). The S184V substitution was introduced into these BAX mutants to enforce mitochondrial localization. These mutants remained inactive in triggering apoptosis upon death signals (Fig. 3.2C). GFP-BAX G108E/S184V targeted at the mitochondria constitutively, whereas GFP-BAX G67R/S184V only exhibited partial mitochondrial localization (Fig. 3.2D). Since our initial study suggests that the N-terminal exposure of BAX likely

reflects mitochondrial targeting, we next tested whether these two double mutants could be pulled down by the 6A7 antibody. Indeed, the N-terminus of BAX G108E/S184V was readily exposed in the absence of apoptotic stimuli whereas that of BAX G67R/S184V was partially exposed (Fig. 3.2E). By analogy to BAX L63E, the mitochondria-targeted BAX G108E/S184V could not be activated by tBID to undergo homo-oligomerization detected by protein cross-linking, and thereby failed to induce apoptosis (Fig. 3.2C, F). We also tested a previously reported BAX P168A mutant that was defective in mitochondrial targeting (Schinzel et al., 2004). This mutant when stably reconstituted in DKO cells could not be immunoprecipitated by the 6A7 antibody (Fig. S3.4). Of note, it was previously reported that the N-terminus of this mutant was exposed when it was overexpressed in HeLa cells that contain wt BAX/BAK (Schinzel et al., 2004). Collectively, the N-terminal exposure of BAX is the conformational change associated with mitochondrial targeting rather than homo-oligomerization. More importantly, our data indicate the mitochondrial targeting and homo-oligomerization are two separable, distinct steps of BAX activation. Homo-oligomerization of BAX is apparently not required for BAX to translocate to mitochondria.

### ***The BH1 and BH3 domains of BAX are required for its activation***

Although both BAX G67R and G108E mutants failed to undergo homo-oligomerization driven by tBID, it remains possible that they have defects even in the earlier step of conformational changes. Indeed, both mutants failed to translocate to mitochondria following intrinsic death signals and were unable to expose their N-terminal epitope in response to DNA damage or tBID (Fig. 3.3A, B), indicating that they have

defects in the first steps of BAX activation. In addition to visualizing mitochondrial targeting, we performed alkaline extraction to quantify the percentage of wt or mutant BAX integrating into the MOM (Goping et al., 1998). BAX was loosely associated with mitochondrial and could be extracted by alkali (Fig. 3.3C). Once activated by tBID, BAX inserted into the MOM and became resistant to alkaline extraction (Fig. 3.3C). By contrast, both G67R and G108E mutants were still sensitive to alkaline extraction, indicating that they failed to insert into the MOM upon tBID treatment. Similar to tBID, BIM and PUMA also directly activated BAX to induce its mitochondrial insertion (Fig. 3.3D). Collectively, intact BH1 and BH3 domains are essential for the activation of BAX by ‘activator’ BH3s.

#### ***The $\alpha 1$ helix of BAX controls the engagement of $\alpha 9$ helix into the dimerization pocket***

The observation that N-terminal exposure of BAX initiates its activation and dictates mitochondrial targeting prompted us to explore how the N-terminal exposure of BAX regulates its mitochondrial targeting. Given that the  $\alpha 9$  helix of BAX occupies its hydrophobic pocket formed by BH1-3 domains to prevent mitochondrial targeting and dimerization (Suzuki et al., 2000), one testable thesis is that the N-terminus stabilizes the engagement of the  $\alpha 9$  helix in the hydrophobic pocket to keep BAX in an inactive conformation. To test this hypothesis, we developed an *in vitro* system to recapitulate the intramolecular interaction between the hydrophobic pocket of BAX and the C-terminal  $\alpha 9$  transmembrane domain (TM). We found that HA-tagged BAX $\Delta$ C could co-precipitate the  $\alpha 9$  helix of BAX fused to the C-terminus of GST using anti-HA immunoprecipitation in the presence of CAHPS (Fig. 3.4A). S184V mutant within the  $\alpha 9$  helix abolished its

association with BAX $\Delta$ C, suggesting that the  $\alpha$ 9 helix of BAX S184V no longer stays in the pocket and becomes available to insert into the MOM. Importantly, deletion of the  $\alpha$ 1 helix in BAX $\Delta$ C (BAX $\Delta$ N $\Delta$ C) disrupted the interaction between the  $\alpha$ 9 helix and the hydrophobic pocket, indicating that the N-terminal  $\alpha$ 1 helix stabilizes the binding of the  $\alpha$ 9 helix to the pocket (Fig. 3.4A). These data are supported by a previously reported demonstration that N-terminally deleted BAX could target to mitochondria constitutively (Goping et al., 1998).

The aforementioned findings led to our next hypothesis—exposure of the  $\alpha$ 1 helix results in the disengagement of the  $\alpha$ 9 helix and subsequent mitochondrial translocation. To test this hypothesis, we developed another *in vitro* system to detect the intramolecular interaction between the  $\alpha$ 1 helix of BAX and BAX $\Delta$ N with deletion of the N-terminal 37 amino acid residues. HA-tagged  $\alpha$ 1 helix of BAX co-precipitated BAX $\Delta$ N using anti-HA immunoprecipitation in the presence of CHAPS (Fig. 3.4B). Of note, NP-40 disrupted this interaction, consistent with the notion that NP-40 induces conformational changes in BAX. (Fig. S3.5). The NMR structure of BAX reveals that the  $\alpha$ 2 helix (BH3 domain) of BAX is in close proximity to its  $\alpha$ 1 helix (Suzuki et al., 2000). This prompted us to investigate whether the mitochondria-targeted BAX  $\alpha$ 2 helix L63E mutant might destabilize the interaction between the  $\alpha$ 1 helix of BAX and BAX $\Delta$ N, resulting in secondary disengagement of the  $\alpha$ 9 helix. Indeed, the  $\alpha$ 1 helix failed to interact with BAX $\Delta$ N containing L63E mutation (Fig. 3.4B). By contrast, another BH3 domain mutation G67R had no effect on this interaction and BAX G67R was cytosolic (Fig. 3.4B). These findings provide a mechanistic basis explaining how a mutation at the BH3 domain affects mitochondrial targeting. Moreover, S184V mutation abrogated the



interaction between the  $\alpha 1$  helix and BAX $\Delta$ N, consistent with the observation that BAX S184V readily exposed its N-terminus (Fig. 3.4C).

***tBID, BIM, and PUMA induce the N-terminal exposure of BAX and remain associated with the N-terminally exposed BAX through the BH1 domain***

As the  $\alpha 1$  helix of BAX controls the pivotal step of conformational changes, we next investigated whether ‘activator’ BH3s initiates BAX activation by binding directly to the  $\alpha 1$  helix of BAX. Indeed, HA-tagged  $\alpha 1$  helix of BAX co-precipitated tBID, BIM, and PUMA, but not BAD or BMF *in vitro* (Fig. 3.4D and Fig. S3.6). These findings are supported by our recently solved NMR structure of BAX complexed with BIM BH3 peptide in which the  $\alpha 1$  and  $\alpha 6$  helices of BAX were involved in the binding with BIM (Gavathiotis et al., 2008). Furthermore, tBID, BIM, and PUMA, but not BAD or BMF, could directly induce the N-terminal exposure of BAX *in vitro* (Fig. 3.4E and S3.7). Co-incubation of BAX with tBID, BIM, and PUMA led to the exposure of  $\alpha 1$  helix of BAX that could be immunoprecipitated with the 6A7 antibody (Fig. 3.4E). Remarkably, tBID, BIM, and PUMA were co-precipitated with the N-terminally exposed BAX using the 6A7 antibody (Fig. 3.4E). Since the  $\alpha 1$  helix is the epitope recognized by the 6A7 antibody, the binding between BH3s and the  $\alpha 1$  helix of BAX must be transient, otherwise activated BAX would not be pulled down by the 6A7 antibody. As BH3s remain associated with the N-terminally exposed BAX, they must bind to a region other than the  $\alpha 1$  helix. The second interaction is probably essential for the subsequent activation of BAX to induce homo-oligomerization since the N-terminal exposure of BAX only contributes to mitochondrial targeting. The N-terminally exposed BAX S184V

mutant did not undergo homo-oligomerization until it was activated by tBID, BIM, and PUMA (Fig. 3.4F). Of note, ‘inactivator’ BH3s such as BAD or BMF failed to induce homo-oligomerization of BAX S184V mutant (Fig. S3.8). To identify the second interaction site between N-terminally exposed BAX and BH3s, we reasoned that the canonical dimerization pocket is the most likely candidate since it is no longer blocked by the  $\alpha 9$  helix and the BH1 domain has been demonstrated to mediate the interaction between BAX and BID (Wang et al., 1996). Since BH1 domain mutant of BAX (G108E) failed to undergo N-terminal exposure triggered by BH3s, we introduced L63E mutation on top of G108E to bypass the first activation step. Indeed, BAX L63E/G108E mutant constitutively exposed its N-terminus and targeted to the mitochondria (data not shown). Importantly, BAX L63E/G108E failed to co-precipitate tBID using the 6A7 antibody (Fig. 3.4G). Furthermore, BAX G108E failed to interact with tBID in NP-40 which induces its N-terminal exposure (Fig. S3.9). Together, our data discover a dynamic interaction between ‘activator’ BH3s and BAX.

***The BH1 and BH3 domains are essential for the assembly of higher-ordered BAK oligomers and the proapoptotic activity of BAK***

To investigate the importance of BH1 and BH3 domains for the proapoptotic activity of BAK, W122A/G123E/R124A (BH1) and L75E (BH3) mutants of BAK were generated. These two mutants failed to form higher-ordered oligomers in response to tBID (Fig. 3.5A). In addition, HA-tagged BH1 or BH3 mutant was unable to co-precipitate non-tagged corresponding mutant by anti-HA immunoprecipitation. (Fig. 3.5B). Accordingly, they were unable to induce apoptosis following intrinsic death

signals when they were reconstituted in DKO cells (Fig. 3.5C). Of note, these two mutants localized at the mitochondrial like wt BAK (Fig. 3.5D). Similar to the N-terminally exposed BAX, the BH1 domain of BAK was involved in its binding to tBID (Fig. 3.5E). Although the N-terminal exposure of human BAK following apoptotic signals was suggested by a conformation-specific antibody (Ab-1) using FACS analysis (Griffiths et al., 1999), mutagenesis studies indicated that it neither correlated with dimerization nor was required for the proapoptotic activity (Dewson et al., 2008). Intriguingly, the epitope recognized by Ab-1 is not clear since it was generated using C-terminal truncated human BAK protein and Ab-1 could not detect mouse BAK even by immunoblots. The enhanced detection of BAK by Ab-1 or Ab-2 during apoptosis may represent a more global conformation change rather than a simple exposure of the  $\alpha 1$  helix of BAK. To address the exposure of the  $\alpha 1$  helix in mouse BAK, we performed immunoprecipitation using antibody specific for the  $\alpha 1$  helix of BAK (NT), which immunoprecipitated comparable amounts of mouse BAK before and after tBID activation in MEFs (Fig. 3.5F). Comparable amounts of BAK were immunoprecipitated before and after staurosporine treatment in two additional mouse cell lines 4T1 (breast cancer) and N18 (neuroblastoma) (Fig. 3.5G). These data suggest that the integral mitochondrial membrane protein BAK constitutively exposes its N-terminal  $\alpha 1$  helix, reminiscent of mitochondrially translocated BAX.

***Death signals initiated from ER require mitochondria- but not ER-localized BAK to execute apoptosis***

BAX and BAK not only control the mitochondrial gateway of apoptosis but also regulate ER calcium homeostasis (Scorrano et al., 2003; Zong et al., 2003). Since BAK is an integral membrane protein that resides at both mitochondria and ER (Scorrano et al., 2003; Zong et al., 2003), we generated BAK chimera proteins that were specifically targeted to ER or mitochondria to determine the contribution of ER calcium regulation to apoptosis controlled by BAK. The transmembrane domain of BAK was replaced by heterologous ER or mitochondrial targeting signals derived from cytochrome b5 and OMP25, respectively (Fig., 3.6A) (Shirane and Nakayama, 2003; Zhu et al., 1996). The restricted localization of BAK $\Delta$ C/Cb5 at ER and that of BAK $\Delta$ C/OMP25 at the mitochondria were confirmed by fusing these chimera proteins with YFP (Fig. S3.10). The proapoptotic activity of these BAK mutants was assessed by reconstituting these BAK mutants in DKO cells. Interestingly, targeting of BAK to the mitochondria restored the apoptotic response of DKO cells not only to staurosporine (a general kinase inhibitor) and etoposide (DNA damage) but also to ER stress induced by tunicamycin and thapsigargin (Fig. 3.6B). By contrast, ER-targeted BAK failed to rescue the apoptotic defect of DKO cells even to ER stress (Fig. 3.6B). The minor difference in activating apoptosis between wt BAK and BAK $\Delta$ C/OMP25 is likely due to the lower protein expression level of BAK $\Delta$ C/OMP25 which was less stable (Fig. S3.1). These data clearly indicate that death signals emanated from ER also converge on mitochondrial BAK to execute apoptosis.

***ER stress induces BIM and PUMA to activate BAX/BAK-dependent mitochondrial death program***

Since BAK needs to be activated by BH3s, we envision that ‘activator’ BH3s must be induced by ER stress to provide the missing link that interconnects ER stress signaling and the BAX/BAK-dependent mitochondrial death program. Indeed, ER stress induced BIM and PUMA proteins (Fig. 3.6C). Consequently, *Bim* or *Puma* single knockout cells were resistance to ER stress-induced apoptosis and doubly deficiency of *Bim* and *Puma* DKO cells provided further protection (Fig. 3.6D). Importantly, ER stress-induced homo-oligomerization of BAX or BAK was blocked by the deficiency of *Bim* and *Puma*, supporting that BIM and PUMA are required to activate BAX/BAK upon ER stress (Fig. 3.6E, F). Collectively, these findings exemplify the essence of BAX/BAK activation driven by ‘activator’ BH3s in the context of normal cell death signaling cascades.

### 3.5. Discussion

How the death effectors BAX and BAK are activated to trigger the mitochondria-dependent death program remains as one of the most vigorously debated topics in apoptosis research (Chipuk and Green, 2008; Youle and Strasser, 2008). Here, we propose a stepwise activation model of BAX and BAK driven by ‘activator’ BH3s, tBID, BIM, and PUMA (Fig. 3.7 and Table 3.1). We demonstrated that the  $\alpha 1$  helix of BAX stabilizes and thereby controls the engagement of the  $\alpha 9$  helix in the dimerization pocket. tBID, BIM, and PUMA bind transiently to the  $\alpha 1$  helix of BAX to unleash auto-inhibition which allows for the structural reorganization by exposing both N- and C- termini. The C-terminal transmembrane domain hence becomes available for insertion into the MOM. tBID, BIM, and PUMA remain associated with the N-terminally exposed BAX to drive the homo-oligomerization of mitochondrially localized BAX. BAK, an integral mitochondrial membrane protein, constitutively exposes its  $\alpha 1$  helix and requires tBID, BIM, and PUMA to trigger its homo-oligomerization. The homo-oligomerization of BAX or BAK appears to involve the interaction between the BH3 domain of one molecule and the canonical dimerization pocket of the other since mutations in either BH1 or BH3 domain abolish their homo-oligomerization, the same strategy utilized for heterodimerization between BH3s and anti-apoptotic BCL-2 members (Sattler et al., 1997; Walensky, 2006). Previous mutagenesis studies often involve overexpression of mutant BAX or BAK in wt cells such that BH3 but not BH1 mutants were defective in triggering apoptosis (Chittenden, 1995; Simonen et al., 1997) Recently, the importance of BH1 and

BH3 domains for the homo-oligomerization of BAX and BAK was reported (Dewson et al, 2008; George et al., 2007).

The “indirect” activation model of BAX/BAK is proposed based in the lack of strong and stable interaction between BH3s and BAX/BAK (Willis et al., 2007). Our study reveals the dynamic nature of the interaction between BH3s and BAX because the conformational changes of BAX apparently involve continuous, step-by-step structural reorganization, which helps explain the difficulty in detecting these interactions. BH3s first attack the  $\alpha 1$  helix of BAX and then interact with BH1 domain once the N- and C-termini are exposed. This is for the first time that stable interaction between BH3s and BAX, at close to 1:1 stoichiometry, could be captured in solution (Fig. 3.4E). The reason why this interaction could be readily detectable is likely due to the block of subsequent conformational changes that requires the presence of lipid microenvironment since the N-terminally exposed BAX is supposed to insert into the MOM. An “embedded together” model has been proposed to emphasize the importance of lipid in the activation of BAX that was facilitated by cardiolipin (Leber et al., 2007). In addition, it was reported that unidentified MOM proteins assist tBID to activate BAX in the formation of lipidic pore (Schafer et al., 2009). The identification of the canonical dimerization pocket as the second interaction site helps reconcile with previous mutagenesis study demonstrating the involvement of BH1 domain in the binding between BAX and BID (Wang et al., 1996). BH1 domain is also required for BAK to interact with tBID. However, this interaction should be “hit-and-run” in nature since the same pocket is also utilized for homo-oligomerization. If BH3s continue to occupy the pocket, it is impossible for BAX or BAK to undergo homo-oligomerization. Indeed, it was reported that tBID was not co-

eluted with higher-ordered BAX oligomers by gel filtration upon TNF $\alpha$ -induced apoptosis (Sundararajan and White, 2001). On the other hand, BH3s bind tightly to the pocket of anti-apoptotic BCL-2 members such that anti-apoptotic BCL-2 members do not homo-oligomerize (Fig. S3.11). Moreover, the fact that BCL-2 was not co-eluted with the higher-ordered BAX/BAK oligomers suggests that BCL-2 is unlikely to inhibit activated BAX/BAK directly (Fig. S3.11). Anti-apoptotic BCL-2 members function like “decoy” death receptors that form inert stable complexes with BH3s but are incapable to assemble the death machinery that permeabilizes the MOM.

Since the  $\alpha$ 1 helix plays pivotal role in initiating BAX activation, it is conceivable that inhibitors of BAX activation likely bind to the  $\alpha$ 1 helix to keep BAX inactive, exemplified by humanin (Guo et al., 2003). On the contrary, VDAC2 binds to the dimerization pocket of BAK to keep BAK in check (Cheng et al., 2003). In the absence of VDAC2, BAK exist as a monomer yet displaying conformational-specific proteolysis sensitivity comparable to activated BAK (Cheng et al., 2003). However, its full activation, i.e. homo-oligomerization, is still dependent on ‘activator’ BH3s (Cheng et al., 2003). By analogy, VDAC2 functions as a brake controlling the BAK-centered death machinery, whereas ‘activator’ BH3s provide the driving force. Our recent genetic study provided *in vivo* evidence demonstrating a critical VDAC2-BAK axis in regulating negative selection and survival of thymocytes (Ren et al., 2009).

Both multidomain proapoptotic and anti-apoptotic BCL-2 members reside at the ER to affect ER Ca<sup>2+</sup> store likely through the modulation of IP3 receptor (Chen et al., 2004; Oakes et al., 2005; White et al., 2005). Interestingly, BCL-2 and BCL-X<sub>L</sub> remain capable of regulating ER Ca<sup>2+</sup> even in *Bax/Bak* DKO cells (Oakes et al., 2005). These



data position anti-apoptotic BCL-2 proteins downstream of BAX/BAK in maintaining ER  $\text{Ca}^{2+}$  homeostasis, a hierarchy opposite to that for the control of mitochondrial apoptosis. We found that mitochondria- but not ER-targeted BAK is indispensable for ER stress-induced apoptosis in which BIM and PUMA function as sentinels interconnecting upstream death signals and downstream death program. BIM was induced by ER stress through CHOP-mediated transcriptional regulation and dephosphorylation-dependent stabilization (Puthalakath et al., 2007), whereas how PUMA is regulated by ER stress remains unclear. The role of BIM in ER stress-induced apoptosis was uncovered recently in that BID was cleaved by Caspase-2 upon ER stress (Upton et al., 2008), which helps explain why double deficiency of *Bim* and *Puma* provides less apoptotic block than the deletion of *Bax* and *Bak*.

In summary, our data propose a stepwise model of BAX/BAK activation that integrates available structural and functional analyses and resolves previously elusive hypothesis. Our study clearly demonstrates the essential axis of ‘activator’ BH3-BAX/BAK in mitochondrial apoptosis.

### 3.6. Figure and table legends

#### **Figure 3.1. Mitochondrial targeting and homo-oligomerization are two separable, essential steps of BAX activation**

(A) C-terminal  $\alpha 9$  helix targets BAX to the mitochondria. Fluorescence microscopy of *Bax/Bak* DKO MEFs reconstituted with GFP-BAX or GFP-BAX $\Delta$ C before or after treatment with staurosporine (12 hr) or etoposide (15 hr).

(B) A single amino acid substitution at the BH3 domain or  $\alpha 9$  helix of BAX constitutively targets BAX to mitochondria. Fluorescence microscopy of *Bax/Bak* DKO MEFs stably reconstituted with BAX S184V or L63E followed by retroviral transduction of DsRed-Mito.

(C) Mitochondrially localized BAX is not constitutively active. DKO MEFs reconstituted with wt or mutant BAX were treated with staurosporine (18 hr), etoposide (18 hr), tunicamycin (TC, 30 hr), or thapsigargin (TG, 30 hr) to induce apoptosis. Cell death was quantified by Annexin-V. Data shown are mean  $\pm$  s.d. from three independent experiments.

(D) BAX S184V displays faster kinetics in comparison with wt BAX. DKO MEFs reconstituted with wt BAX or BAX S184V were treated with etoposide or tunicamycin for the indicated time. Cell death was quantified by Annexin-V. Data shown are mean  $\pm$  s.d. from three independent experiments. Asterisk,  $P < 0.05$

(E) Mitochondrially localized BAX mutants or activated BAX expose the N-terminal  $\alpha 1$  helix. DKO MEFs reconstituted with wt BAX before and after treatment with etoposide for 15 hr, or reconstituted with indicated BAX mutants were lysed in 1 % CHAPS and

then immunoprecipitated with the 6A7 antibody. Immunoprecipitates were analyzed by anti-BAX (N20) immunoblots.

(F) BH3 domain is required for the homo-oligomerization of BAX. Mitochondria isolated from DKO MEFs reconstituted with BAX S184V or L63E were incubated with recombinant tBID (1 ng/ $\mu$ l) and solubilized in 2 % CHAPS buffer. Protein lysates (200  $\mu$ g) were subjected to Superdex 200 (HR 10/30) gel filtration chromatography and fractions were analyzed by anti-BAX immunoblots.

Data shown in (C) and (D) are mean  $\pm$  s.d. from three independent experiments. Cell death was quantified by Annexin-V.

### **Figure 3.2. Characterization of homo-oligomerization and mitochondrial targeting of BAX**

(A) BH1 and BH3 domain mutants of BAX fail to undergo homo-oligomerization in response to tBID. Mitochondria isolated from DKO MEFs reconstituted with wt or mutant BAX were treated with recombinant tBID (1 ng/ $\mu$ l) and solubilized in 2 % CHAPS buffer. Protein lysates (200  $\mu$ g) were subjected to Superdex 200 (HR 10/30) gel filtration chromatography and fractions were analyzed by anti-BAX immunoblots.

(B and C) BH1 and BH3 domain mutants of BAX fail to trigger apoptosis. DKO MEFs reconstituted with wt BAX or indicated BAX mutant were treated with staurosporine (18 hr), etoposide (18 hr), tunicamycin (TC, 30 hr), or thapsigargin (TG, 30 hr) to induce apoptosis. Cell death was quantified by Annexin-V. Data shown are mean  $\pm$  s.d. from three independent experiments.

(D) S184V mutation fully targets BAX G108E but only partially targets BAX G67R to the mitochondria. Fluorescence microscopy of DKO MEFs reconstituted with the indicated GFP-tagged BAX mutants.

(E) The N-terminal exposure of BAX correlates with mitochondrial targeting. DKO MEFs reconstituted with wt BAX before and after treatment with etoposide (15 hr), or reconstituted with indicated BAX mutants were lysed in 1 % CHAPS and then immunoprecipitated with the 6A7 antibody. Immunoprecipitates were analyzed by anti-BAX (N20) immunoblots.

(F) BH1 domain is required for the homo-oligomerization of BAX. Mitochondria isolated from DKO MEFs reconstituted with BAX S184V or BAX G108E/S184V were incubated with recombinant tBID for 30 min and then treated with BMH crosslinker. The BAX oligomers were detected by an anti-BAX immunoblot.

### **Figure 3.3. BH1 and BH3 domains of BAX are required for its activation**

(A) BH1 and BH3 domain mutants of BAX fail to translocate to mitochondria upon apoptotic signals. Fluorescence microscopy of *Bax/Bak* DKO MEFs reconstituted with GFP tagged wt BAX, BAX G67R, or BAX G108E before or after treatment with staurosporine (12 hr) or etoposide for (15 hr).

(B) BH1 and BH3 domain mutants of BAX fail to expose their  $\alpha$ 1 helix in response to DNA damage or tBID. DKO MEFs reconstituted with wt or mutant BAX were untreated, treated with etoposide, or transduced with retrovirus expressing tBID. Cells lysed in 1 % CHAPS were subject to the 6A7 immunoprecipitation, followed by an anti-BAX immunoblot.

(C) BH1 and BH3 domain mutants of BAX fail to insert into the MOM in response to tBID. Mitochondria isolated from DKO MEFs reconstituted wt or mutant BAX were mock treated or treated with IVTT tBID, followed by alkaline extraction. The alkali-sensitive supernatant (S) and alkali-resistant pellet (P) fractions were analyzed by anti-BAX immunoblots. The numbers shown denote the percent of BAX quantified by densitometry.

(D) BIM and PUMA induce the mitochondrial insertion of BAX. Mitochondria isolated from DKO MEFs reconstituted with wt BAX were mock treated for treated with IVTT BIM or PUMA, followed by alkali extraction. The alkali-sensitive supernatant (S) and alkali-resistant pellet (P) fractions were analyzed by anti-BAX immunoblots. The numbers shown denote the percent of BAX quantified by densitometry.

**Figure 3.4. Activation of BAX can be dissected into two sequential steps, mitochondrial targeting and homo-oligomerization, both of which require ‘activator’ BH3s**

(A) The  $\alpha 1$  helix of BAX keeps the  $\alpha 9$  helix engaged in the dimerization pocket. Radiolabeled IVTT HA-tagged BAX $\Delta$ C or HA-tagged BAX $\Delta$ N $\Delta$ C in combination with GST- $\alpha 9$  or GST- $\alpha 9$  S184V were subjected to anti-HA immunoprecipitation in 1 % CHAPS. Immunoprecipitates and pre-IP input were analyzed by NuPAGE and autoradiography. Asterisk denotes degradation products.

(B) The L63E mutation in BAX disrupts the binding of the  $\alpha 1$  helix to the rest of the protein, resulting in N-terminal exposure and mitochondrial targeting. Radiolabeled IVTT HA<sub>3</sub>-tagged BAX  $\alpha 1$  helix in combination with BAX $\Delta$ N wt, L63E, or G67R were

subjected to anti-HA immunoprecipitation in 1 % CHAPS. Immunoprecipitates and pre-IP input were analyzed by NuPAGE and autoradiography.

(C) The S184V mutation in BAX destabilizes the binding of the  $\alpha 1$  helix to the rest of the protein. Radiolabeled IVTT HA<sub>3</sub>-tagged BAX  $\alpha 1$  helix in combination with BAX $\Delta$ N wt or S184V were subjected to anti-HA immunoprecipitation in 1 % CHAPS. Immunoprecipitates and pre-IP input were analyzed by NuPAGE and autoradiography.

(D) tBID, BIM, and PUMA bind to the  $\alpha 1$  helix of BAX. Radiolabeled IVTT HA<sub>3</sub>-tagged BAX  $\alpha 1$  helix in combination with tBID, BIM, and PUMA were subjected to anti-HA immunoprecipitation in 1 % CHAPS. Immunoprecipitates and pre-IP input were analyzed by NuPAGE and autoradiography.

(E) tBID, BIM, and PUMA, but not BAD, induce the N-terminal exposure of BAX and remain associated with the N-terminally exposed BAX. Radiolabeled IVTT BAX incubated with tBID, BIM, PUMA, or BAD were immunoprecipitated with the 6A7 antibody in 1 % CHAPS. Immunoprecipitates and pre-IP input were analyzed by NuPAGE and autoradiography.

(F) tBID, BIM, and PUMA induce the homo-oligomerization of BAX S184V. Mitochondria isolated from DKO MEFs reconstituted with BAX S184V were incubated with IVTT tBID, BIM, or PUMA for 30 min and then treated with BMH crosslinker. The BAX oligomers were detected by an anti-BAX immunoblot.

(G) BH1 domain is required for N-terminally exposed BAX to interact with tBID. Radiolabeled IVTT BAX L63E or L63E/G108E incubated with tBID were immunoprecipitated with the 6A7 antibody in 1 % CHAPS. Immunoprecipitates and pre-IP input were analyzed by NuPAGE and autoradiography.

**Figure 3.5. BH1 and BH3 domains are required for the homo-oligomerization and proapoptotic activity of BAK**

(A) BH1 and BH3 domain mutants of BAK fail to undergo homo-oligomerization in response to tBID. Mitochondria isolated from DKO MEFs reconstituted with wt or mutant BAK were treated with recombinant tBID (1 ng/ $\mu$ l) and solubilized in 2 % CHAPS buffer. Protein lysates (200  $\mu$ g) were subjected to Superdex 200 (HR 10/30) gel filtration chromatography and fractions were analyzed by anti-BAK immunoblots.

(B) BH1 and BH3 domain mutants of BAK fail to form homo-dimers. Radiolabeled IVTT HA<sub>3</sub>-tagged wt or mutant BAK plus non-tagged counterparts were immunoprecipitated with anti-HA antibody. Immunoprecipitates and pre-IP input were analyzed by NuPAGE and autoradiography. Asterisk denotes degradation products.

(C) BH1 and BH3 domain mutants of BAK fail to trigger apoptosis. DKO MEFs reconstituted with wt or mutant BAK were treated with staurosporine (18 hr), etoposide (18 hr), tunicamycin (30 hr), or thapsigargin (30 hr) to induce apoptosis. Cell death was quantified by Annexin-V. Data shown are mean  $\pm$  s.d. from three independent experiments.

(D) BH1 and BH3 domain mutants of BAK are localized at the mitochondria. Fluorescence microscopy of *Bax/Bak* DKO MEFs stably reconstituted with YFP-tagged wt or mutant BAK followed by retroviral transduction of DsRed-Mito.

(E) BH1 domain is required for BAK to interact with tBID. Radiolabeled IVTT BAK wt, BAK BH3 mt (L75E) or BH1 mt (W122A/G123E/R124A) incubated with tBID-HA were immunoprecipitated with anti-HA antibody. Immunoprecipitates and pre-IP input were analyzed by NuPAGE and autoradiography.

(F) BAK constitutively exposes its N-terminal  $\alpha 1$  helix. Mitochondria isolated from wt MEFs, mock treated or treated with tBID, were lysed in 1 % CHAPS and then immunoprecipitated with the  $\alpha 1$  helix specific anti-BAK antibody (NT). Immunoprecipitates and pre-IP input were analyzed by anti-BAK (G23) immunoblots. Mitochondria isolated from DKO MEFs serve as a negative control.

(G) BAK constitutively exposes its N-terminal  $\alpha 1$  helix. 4T1 or N18 cells before and after staurosporine treatment were lysed in 1 % CHAPS and then immunoprecipitated with the  $\alpha 1$  helix specific anti-BAK antibody (NT). Immunoprecipitates and pre-IP input were analyzed by anti-BAK (G23) immunoblots.

**Figure 3.6. BIM and PUMA activate mitochondrial BAK and BAX to execute apoptosis upon ER stress**

(A) Schematic of the mitochondria- and ER-targeted BAK chimera mutants.

(B) Mitochondria- but not ER-targeted BAK is required for apoptosis triggered by intrinsic death signals. DKO MEFs reconstituted with wt or mutant BAK were treated with staurosporine (9 hr), etoposide (18 hr), tunicamycin (TC, 30 hr), or thapsigargin (30 hr) to induce apoptosis. Cell death was quantified by Annexin-V. Data shown are mean  $\pm$  s.d. from three independent experiments.

(C) BIM and PUMA are induced by ER stress. DKO MEFs treated with tunicamycin (TC, 18 hr), or thapsigargin (18 hr) were lysed and analyzed by anti-BIM and PUMA immunoblots.

(D) BIM and PUMA are required for ER-stress induced apoptosis. Wild-type, *Bim* KO, *Puma* KO, or *Bim/Puma* DKO MEFs were treated with tunicamycin or thapsigargin for



30 hr. Cell death was quantified by Annexin-V. Data shown are mean  $\pm$  s.d. from three independent experiments.

(E) Deficiency of *Bim* and *Puma* prevents ER stress-induced BAK homo-oligomerization. Wild-type or *Bim/Puma* DKO MEFs were untreated or treated with tunicamycin for 30 hr. Protein lysates were subjected to Superdex 200 (HR10/30) gel filtration chromatography. Fractions were analyzed by anti-BAK immunoblots.

(F) Deficiency of *Bim* and *Puma* prevents ER stress-induced BAX homo-oligomerization. The blots shown in (E) were stripped and reprobed with anti-BAX antibody.

**Figure 3.7. Schematic depicts the model for activation of BAX and BAK driven by “activator” BH3s**

**Table 3.1. Summary of BAX and BAK mutants**

*Supplementary figure legends*

**Figure S3.1. Reconstitution of BAX or BAK mutants to *Bax/Bak* DKO MEFs**

(A) Anti-BAX immunoblots detect comparable expression of wild-type or mutant BAX reconstituted in *Bax/Bak* DKO cells by retroviral transduction.

(B) Anti-BAK immunoblots detect comparable expression of wild-type or mutant BAK reconstituted in *Bax/Bak* DKO cells by retroviral transduction. Of note, BAK $\Delta$ C/OMP25 was less stable, and expressed at a lower level.

**Figure S3.2. *Bax*-deficient MEFs displays faster death kinetics in comparison with *Bak*-deficient MEFs**

(A) *Bax*- or *Bak*-deficient MEFs were treated with etoposide for the indicated time.

(B) *Bax*- or *Bak*-deficient MEFs were treated with tunicamycin for the indicated time.

Cell death was quantified by Annexin-V. Data shown are mean  $\pm$  s.d. from three independent experiments.

**Figure S3.3. BH1 and BH3 domain mutants of BAX fail to form homo-dimers**

*In vitro* transcribed and translated, radiolabeled N-terminal HA-tagged wild-type or mutant BAX plus non-tagged counterparts were immunoprecipitated with anti-HA antibody. Immunoprecipitates and pre-IP input were analyzed by NuPAGE and autoradiography.

**Figure S3.4. BAX P168A fails to expose its N-terminus upon DNA damage**

*Bax/Bak* DKO MEFs reconstituted with wild-type BAX or BAX P168A before or after treatment with etoposide for 15 hr were lysed in 1 % CHAPS and then immunoprecipitated with the 6A7 anti-BAK antibody (NT). Immunoprecipitates and pre-IP input were analyzed by anti-BAX (N20) immunoblots.

**Figure S3.5. NP-40 disrupts the binding of the  $\alpha 1$  helix of BAX to BAX $\Delta$ N**

Radiolabeled IVTT HA<sub>3</sub>-tagged BAX  $\alpha 1$  helix in combination with BAX $\Delta$ N were subjected to anti-HA immunoprecipitation in 0.2 % NP-40. Immunoprecipitates and pre-IP input were analyzed by NuPAGE and autoradiography.

**Figure S3.6. tBID, but not BAD or BMF binds to the  $\alpha 1$  helix of BAX**

Radiolabeled IVTT HA<sub>3</sub>-tagged BAX  $\alpha 1$  helix in combination with tBID, BAD, or BMF were subjected to anti-HA immunoprecipitation in 1 % CHAPS. Immunoprecipitates and pre-IP input were analyzed by NuPAGE and autoradiography.

**Figure S3.7. tBID, but not BMF induces the N-terminal exposure of BAX and remains associated with the N-terminally exposed BAX**

Radiolabeled IVTT BAX incubated with tBID, or BMF were immunoprecipitated with the 6A7 antibody in 1 % CHAPS. Immunoprecipitates and pre-IP input were analyzed by NuPAGE and autoradiography.

**Figure S3.8. tBID, but not BMF induces the homo-oligomerization of BAX S184V**

Mitochondria isolated from *Bax/Bak* DKO MEFs reconstituted with BAX S184V were incubated with IVTT tBID, BAD, or BMF for 30 min and then treated with BMH crosslinker. The BAX oligomers were detected by an anti-BAX immunoblot.

**Figure S3.9. BH1 domain is required for N-terminally exposed BAX to interact with tBID**

Radiolabeled IVTT BAX incubated with tBID were immunoprecipitated with the 6A7 antibody in 0.2 % NP-40. Immunoprecipitates and pre-IP input were analyzed by NuPAGE and autoradiography.

**Figure S3.10. YFP-BAK $\Delta$ C/Cb5 TM colocalizes with DsRed-ER whereas YFP-BAK $\Delta$ C/OMP25 TM colocalizes with DsRed-Mito**

Fluorescence microscopy of *Bax/Bak* DKO MEFs stably reconstituted with indicated YFP-tagged BAK chimera followed by retroviral transduction of DsRed-ER or DsRed-Mito.

**Figure S3.11. BCL-2 does not homo-oligomerize in response to tBID**

(A) Mitochondria isolated from *Bax/Bak* DKO MEFs reconstituted with wild-type BAX were treated with recombinant tBID (1 ng/ $\mu$ l) and solubilized in 2 % CHAPS buffer. Protein lysates (200  $\mu$ g) were subjected to Superdex 200 (HR 10/30) gel filtration chromatography. The membranes utilized in Fig. 3.2A were stripped and reprobbed with anti-BCL-2.

(B) Mitochondria isolated from *Bax/Bak* DKO MEFs reconstituted with wild-type BAK were treated with recombinant tBID (1 ng/ $\mu$ l) and solubilized in 2 % CHAPS buffer. Protein lysates (200  $\mu$ g) were subjected to Superdex 200 (HR 10/30) gel filtration chromatography. The membranes utilized in Fig. 3.5A were stripped and reprobed with anti-BCL-2.

### 3.7. Figures and tables

Figure 3.1

**A**

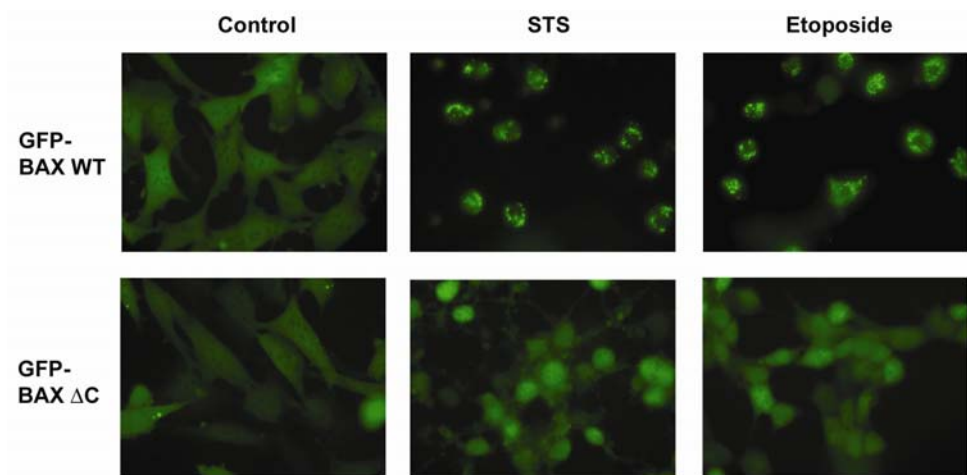

**B**

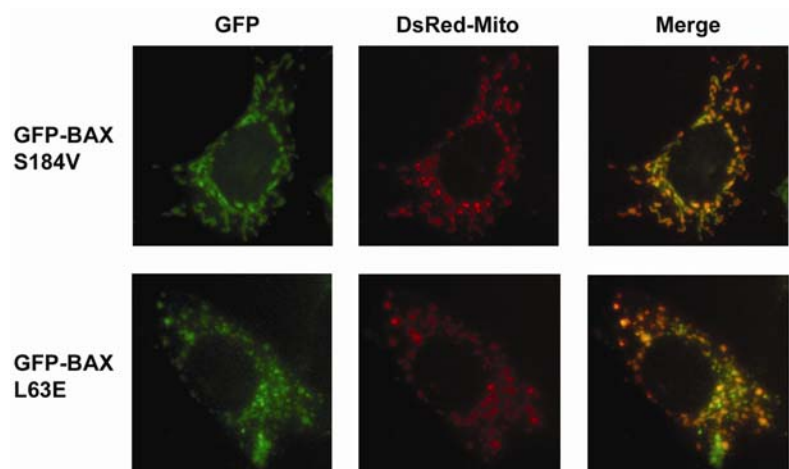
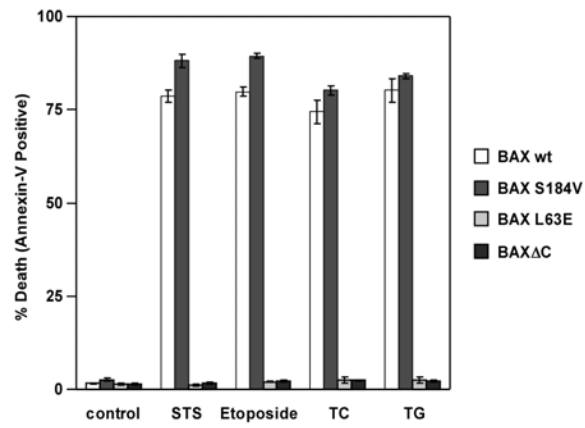

Figure 3.1

C



D

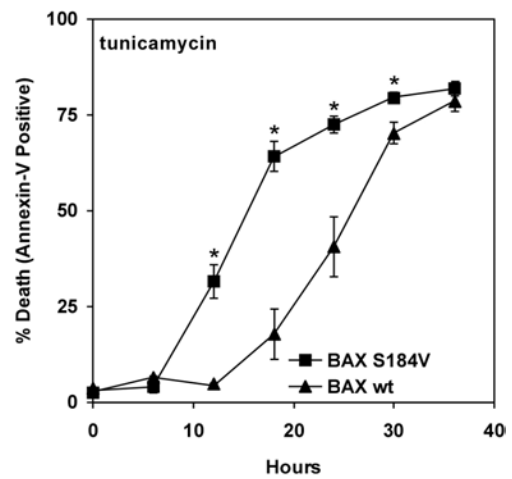
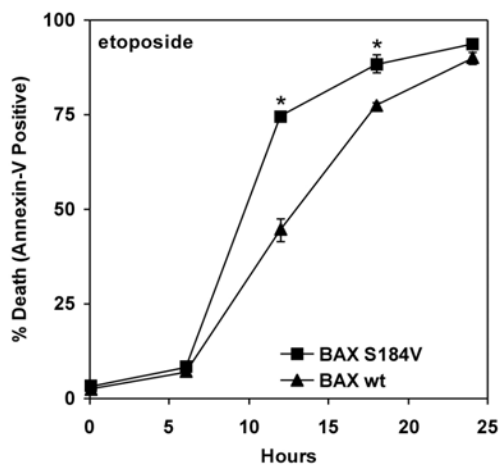
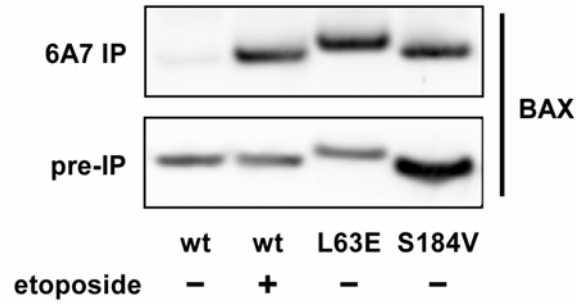

Figure 3.1

**E**



**F**

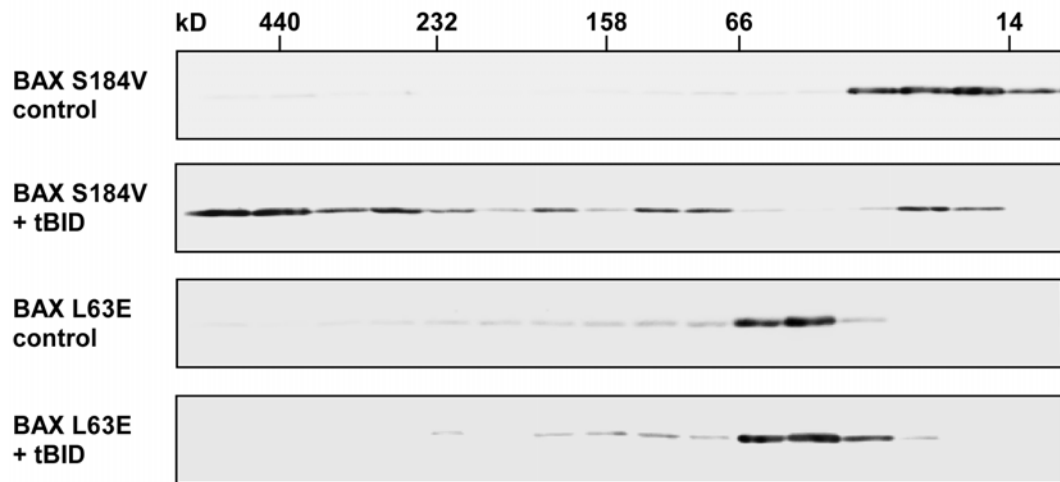



Figure 3.2

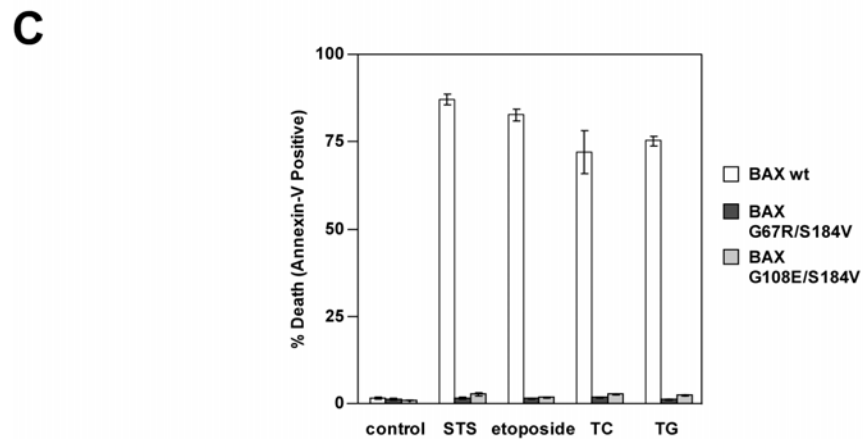
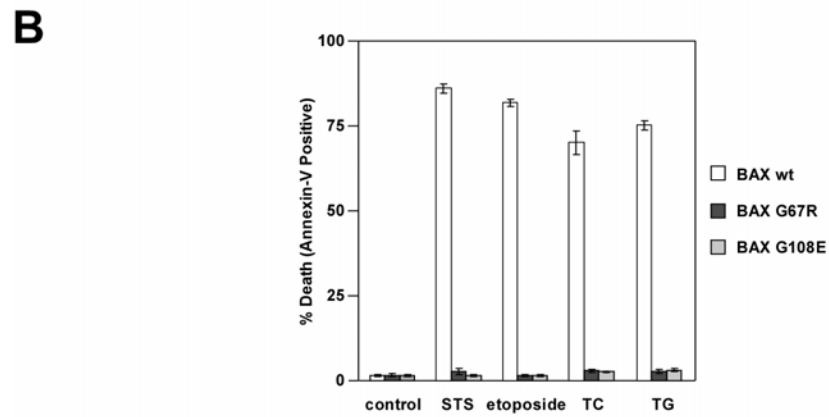
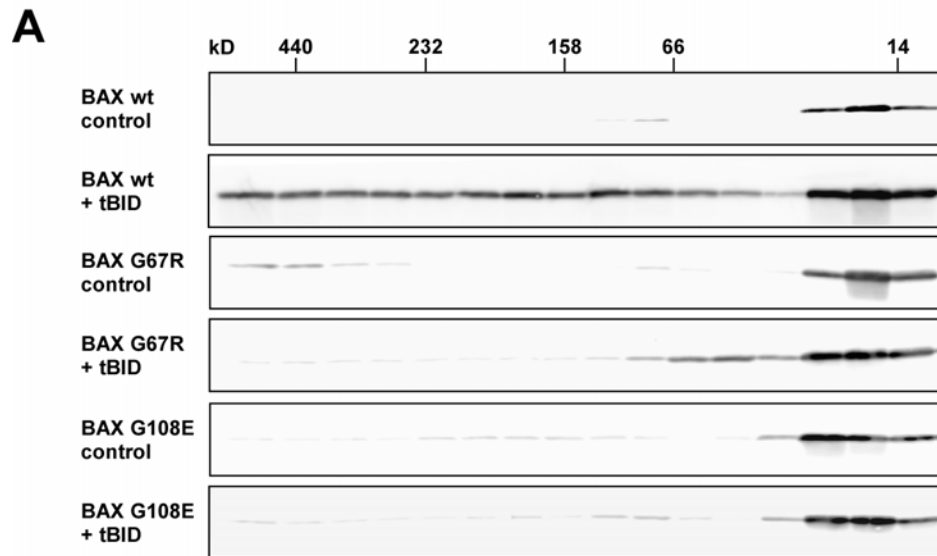
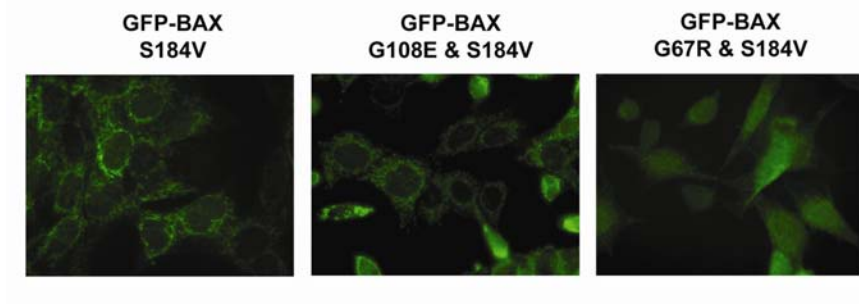
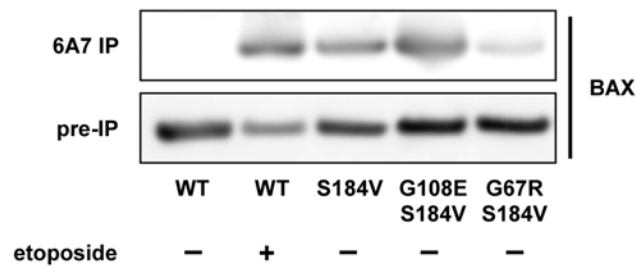

Figure 3.2

**D**



**E**



**F**

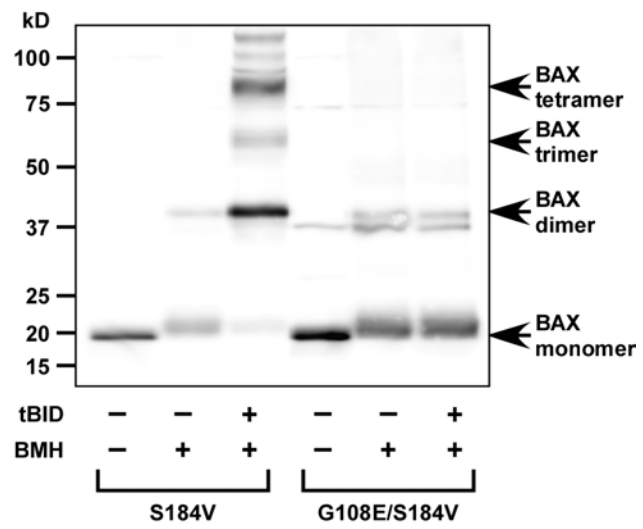

Figure 3.3

**A**

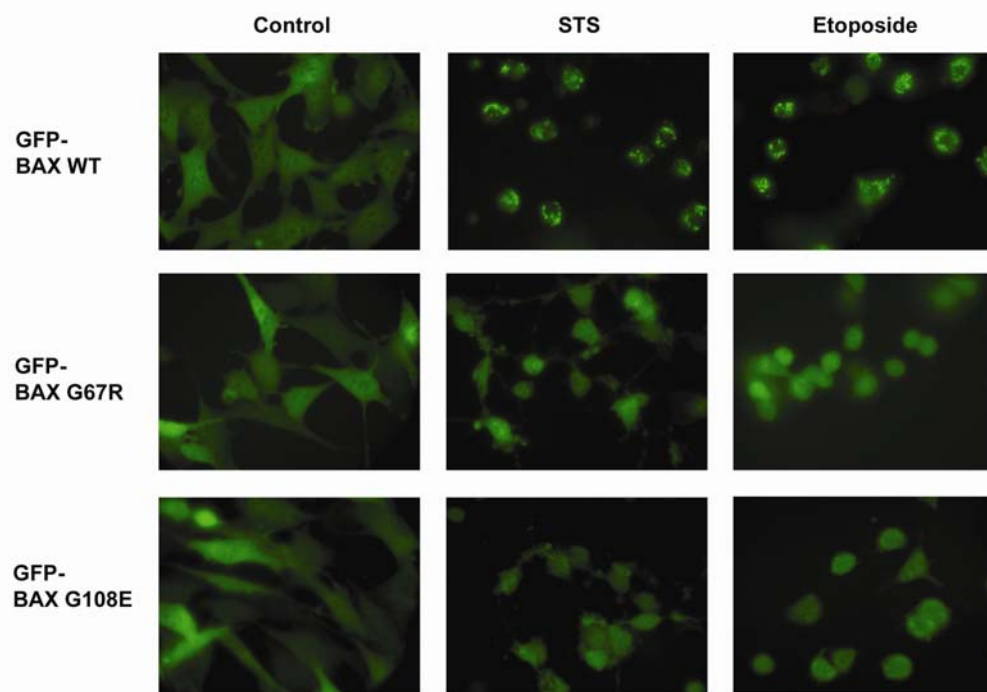
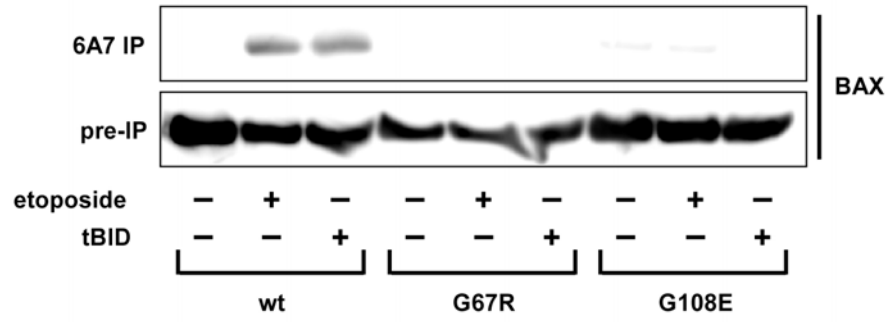
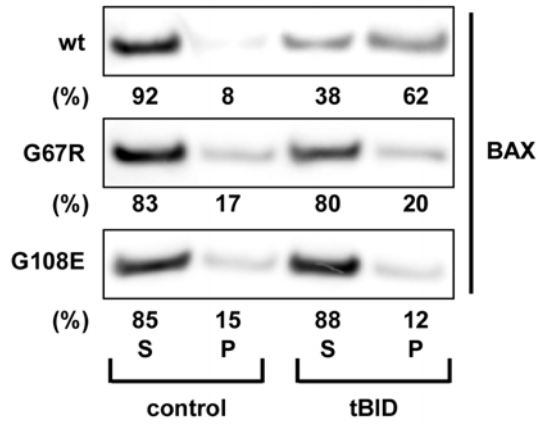

Figure 3.3

**B**



**C**



**D**

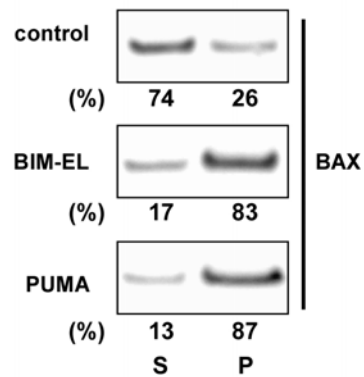

Figure 3.4

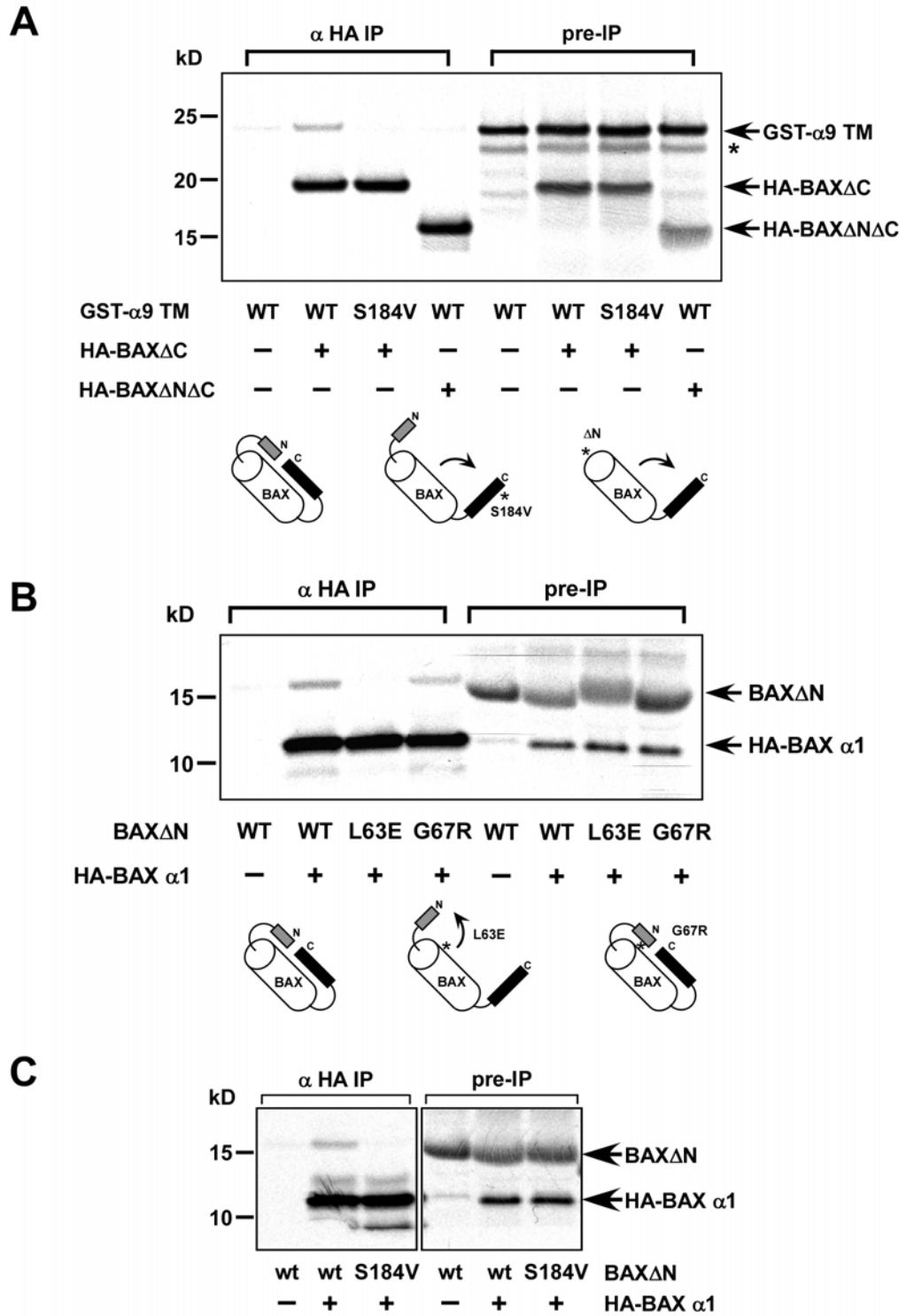
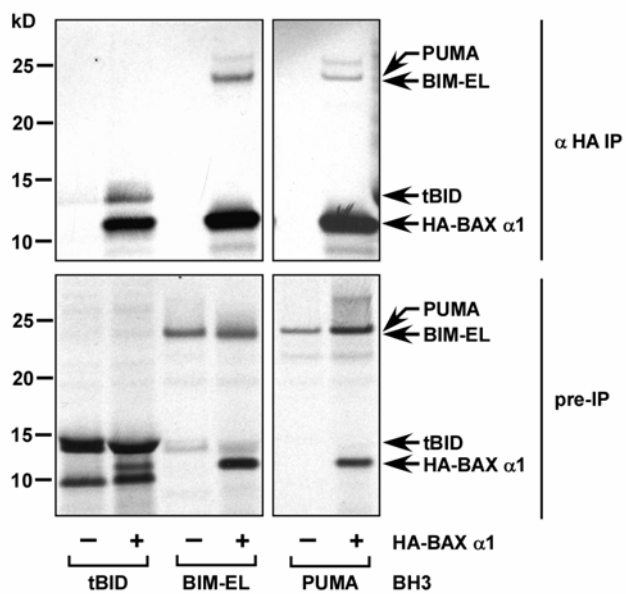

Figure 3.4

D



E

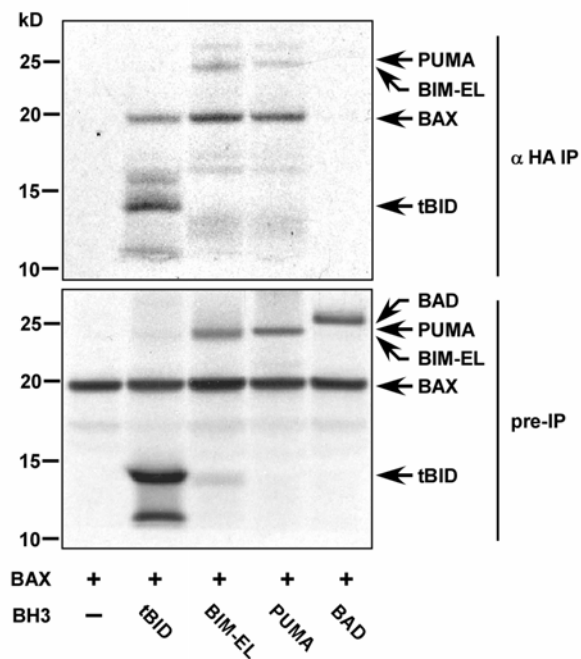
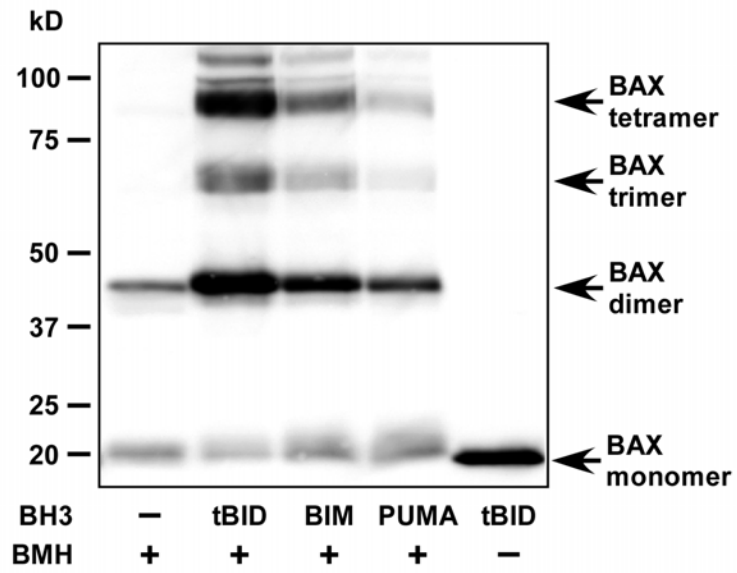

Figure 3.4

**F**



**G**

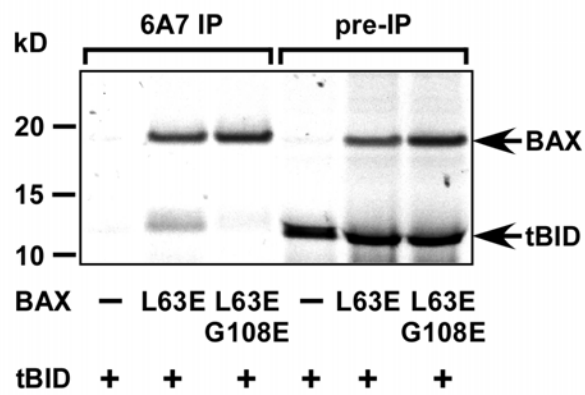

Figure 3.5

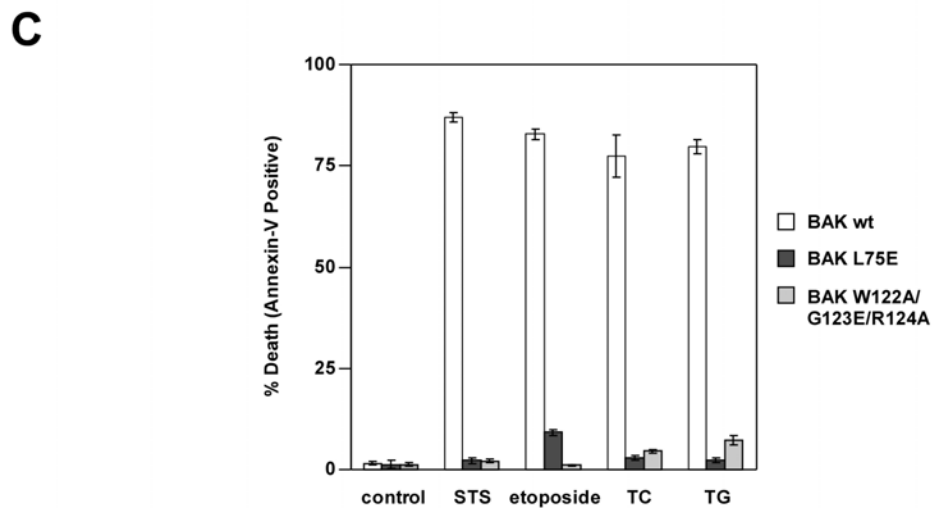
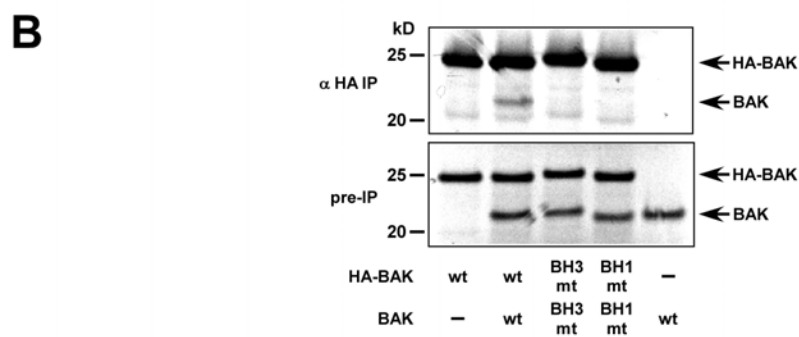
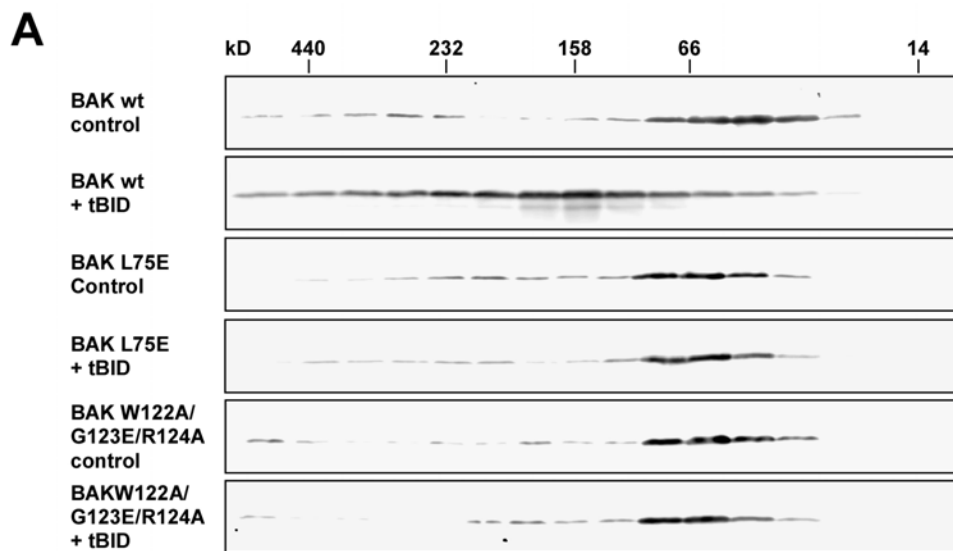



Figure 3.5

D

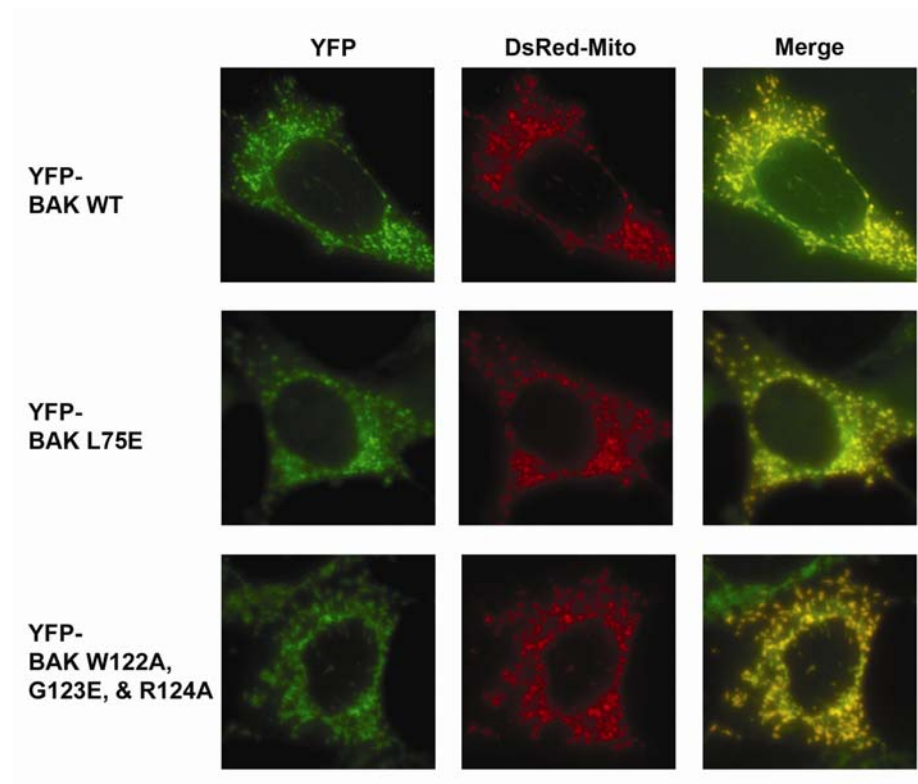
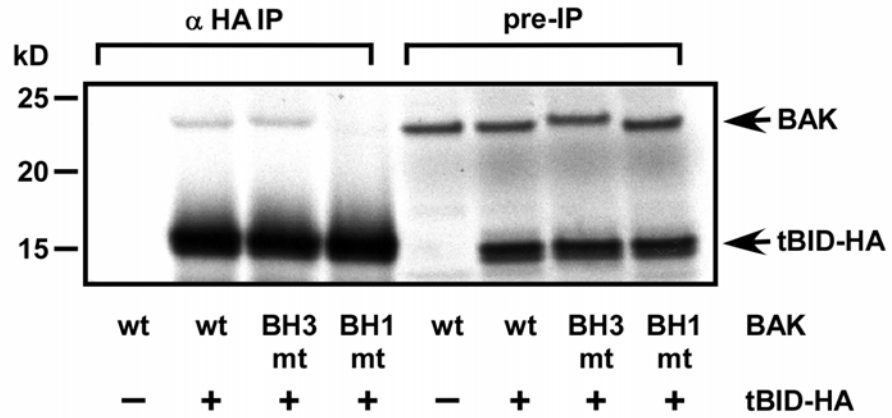
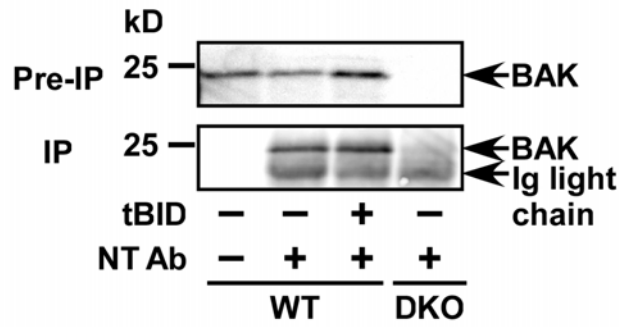

Figure 3.5

**E**



**F**



**G**

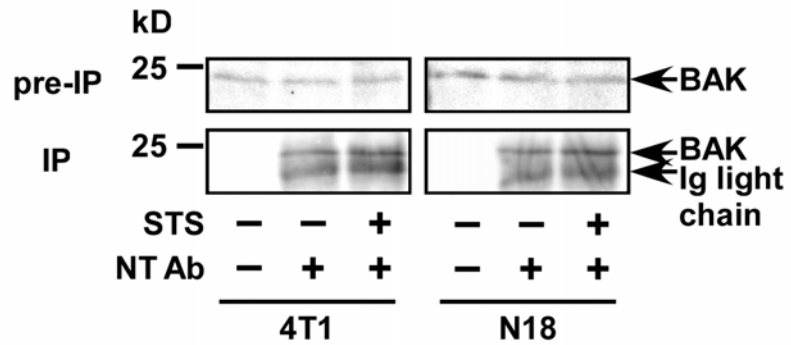
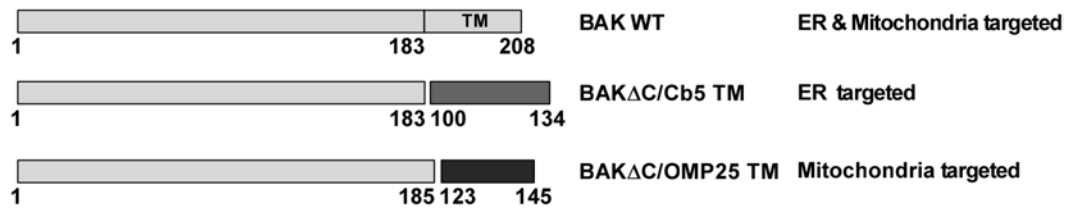
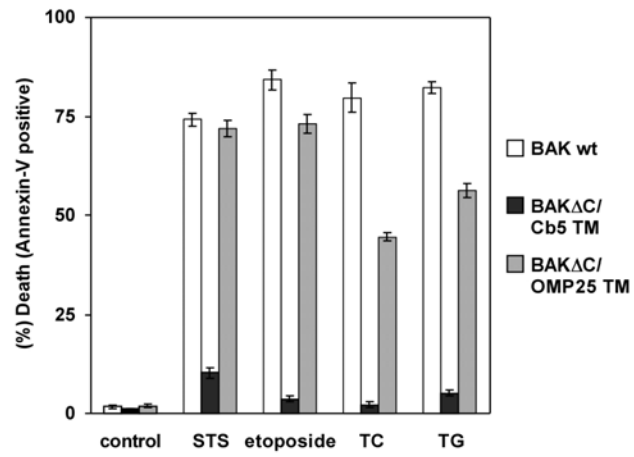

Figure 3.6

**A**



**B**



**C**

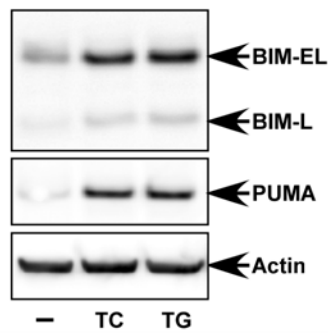
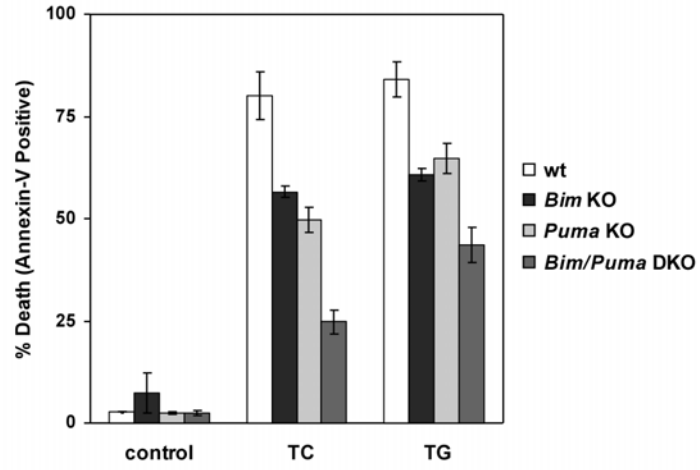
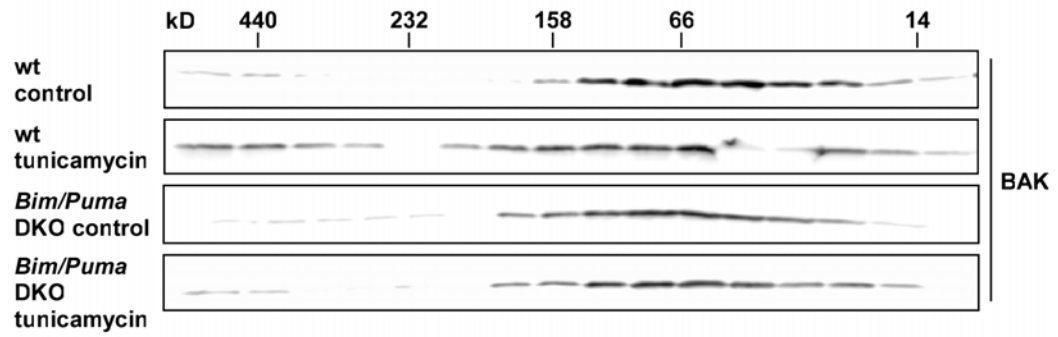

Figure 3.6

D



E



F

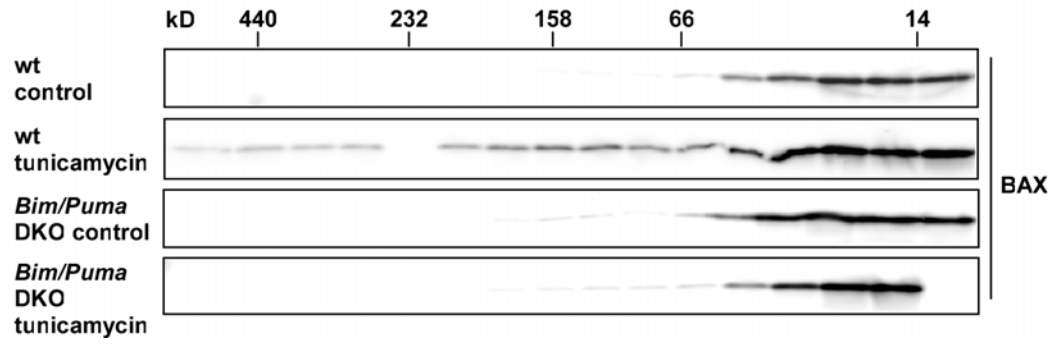
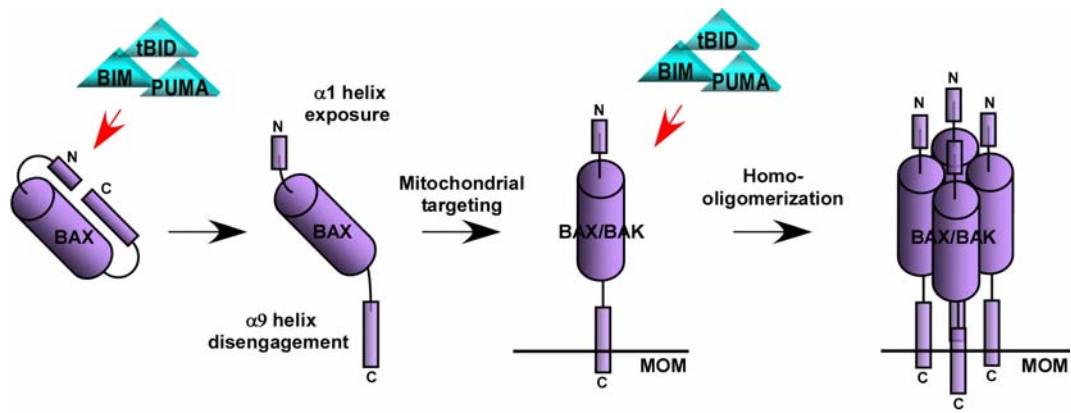

Figure 3.7

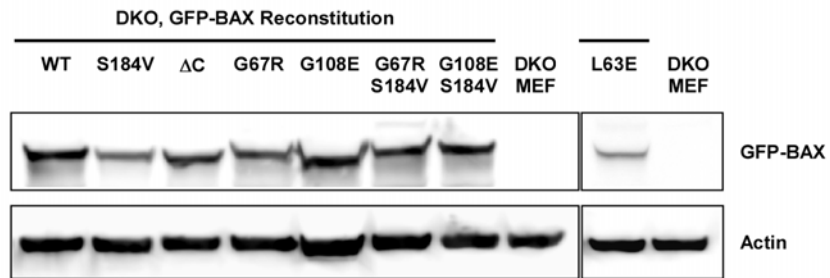
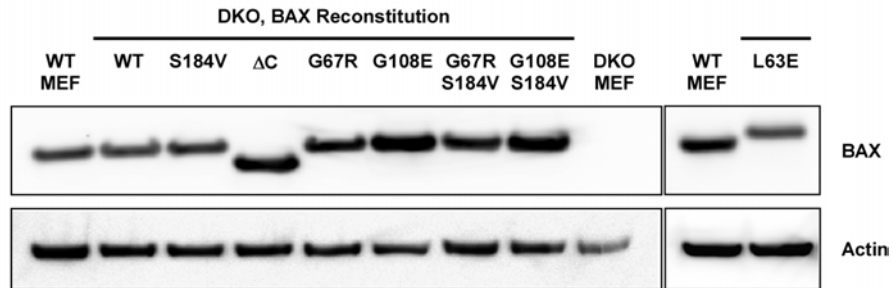

**Table 3.1**

<b>Mutation</b>	<b>Domain</b>	<b>Localization</b>	<b>Bind BH3s</b>	<b>Defect</b>
BAX L63E	BH3	Mitochondria	yes	Oligomerization
BAX S184V	TM	Mitochondria	ND	no
BAX G67R	BH3	Cytosol	ND	Mitochondrial insertion & oligomerization
BAX G108E	BH1	Cytosol	no	Mitochondrial insertion & oligomerization
BAX G67R/S184V	BH3 & TM	Mitochondria/ Cytosol	ND	oligomerization
BAX G108E/S184V	BH1 & TM	Mitochondria	ND	Oligomerization
BAK L75E	BH3	Mitochondria	yes	Oligomerization
BAK W122A/G123E/R124A	BH1	Mitochondria	no	Oligomerization

Figure S3.1

**A**



**B**

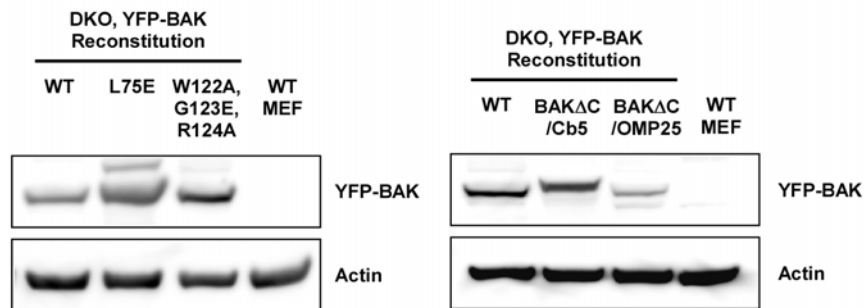
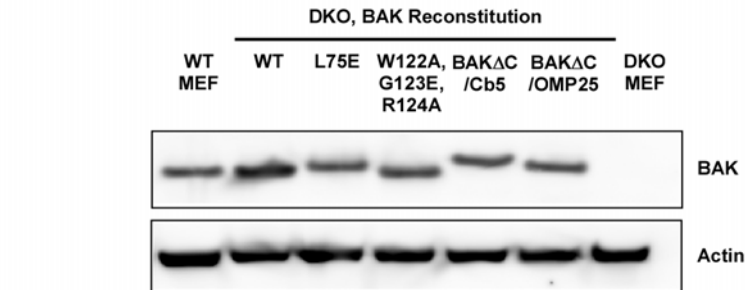
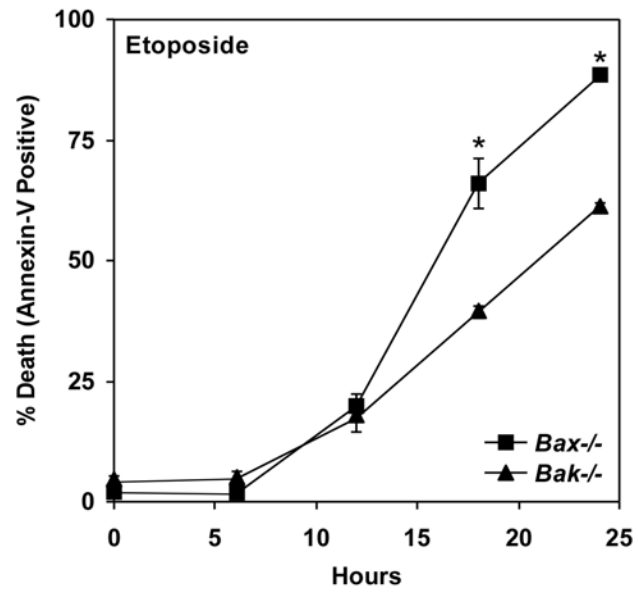

Figure S3.2

**A**



**B**

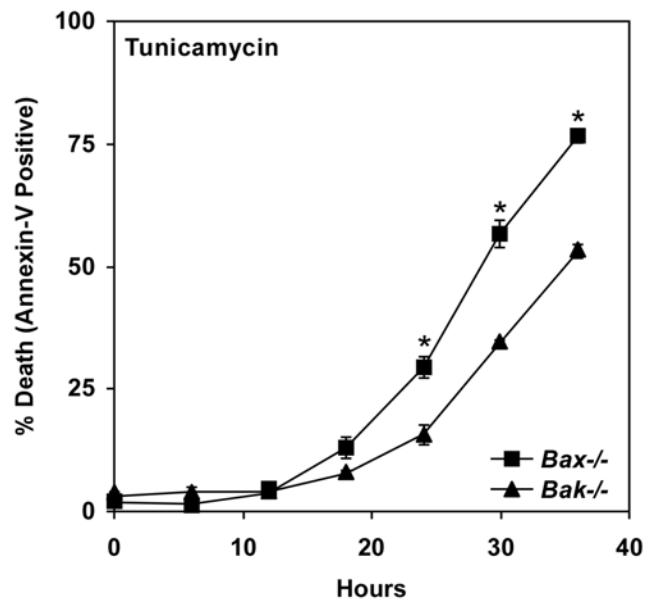



Figure S3.3

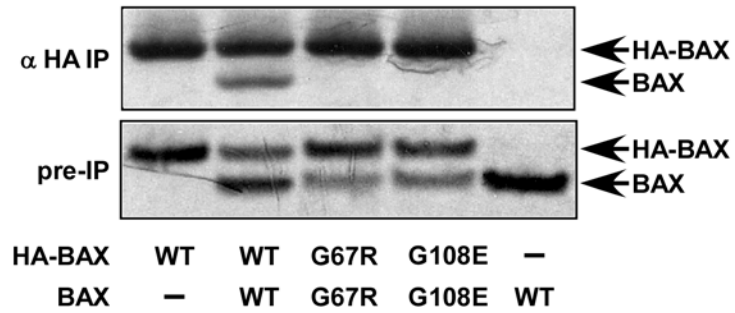

Figure S3.4

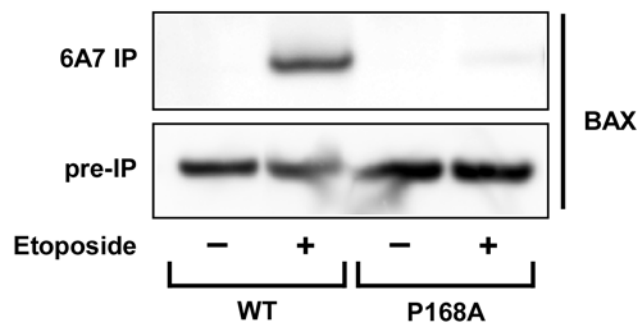

Figure S3.5

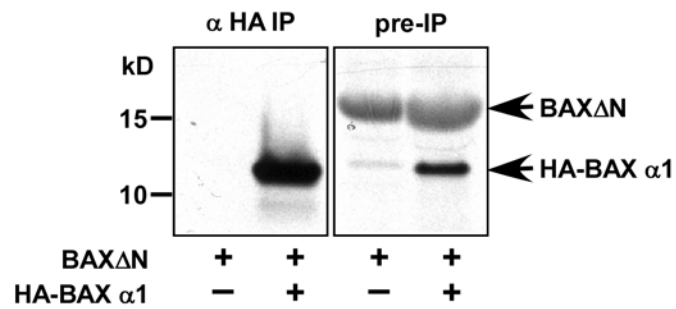

Figure S3.6

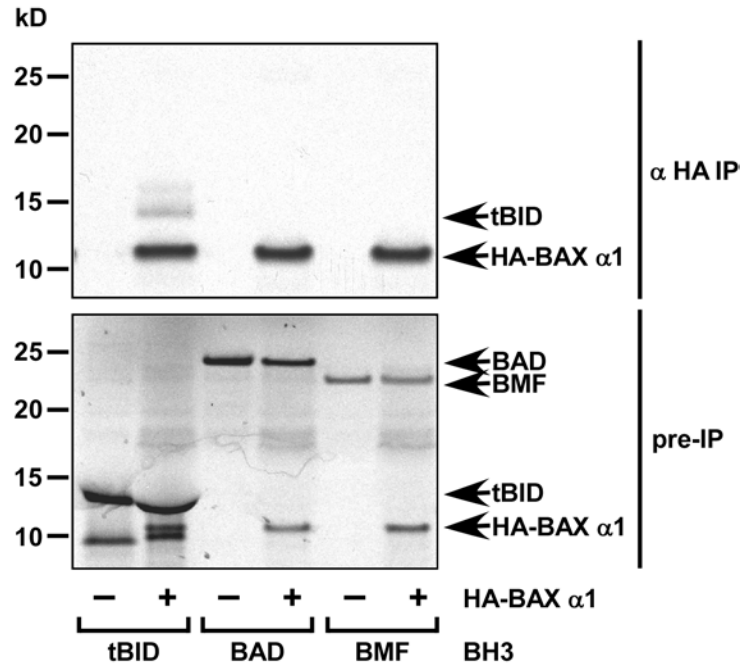
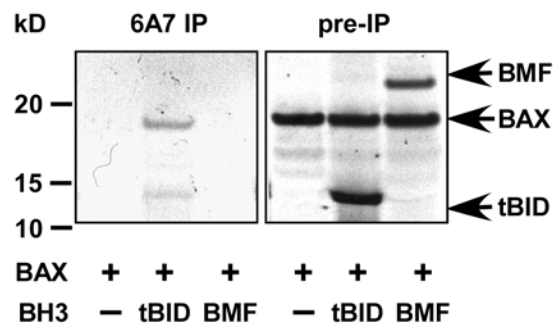
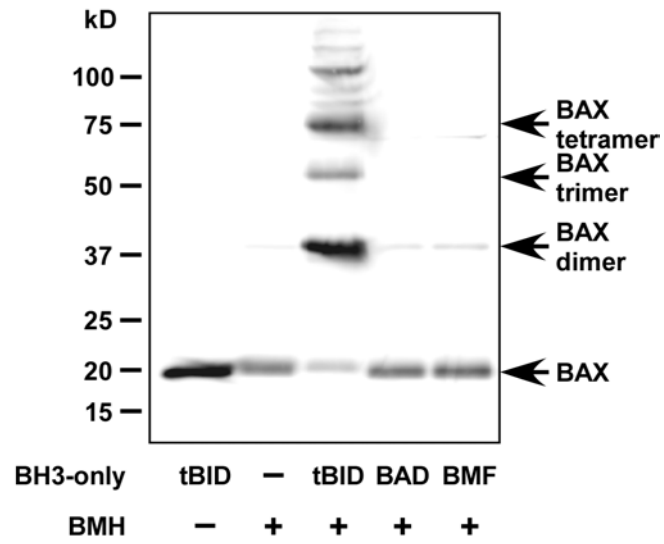

Figure S3.7



**Figure S3.8**



**Figure S3.9**

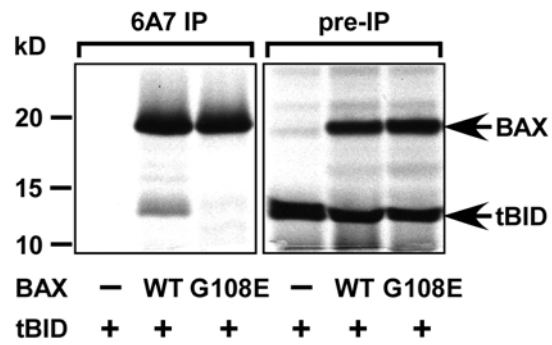

Figure S3.10

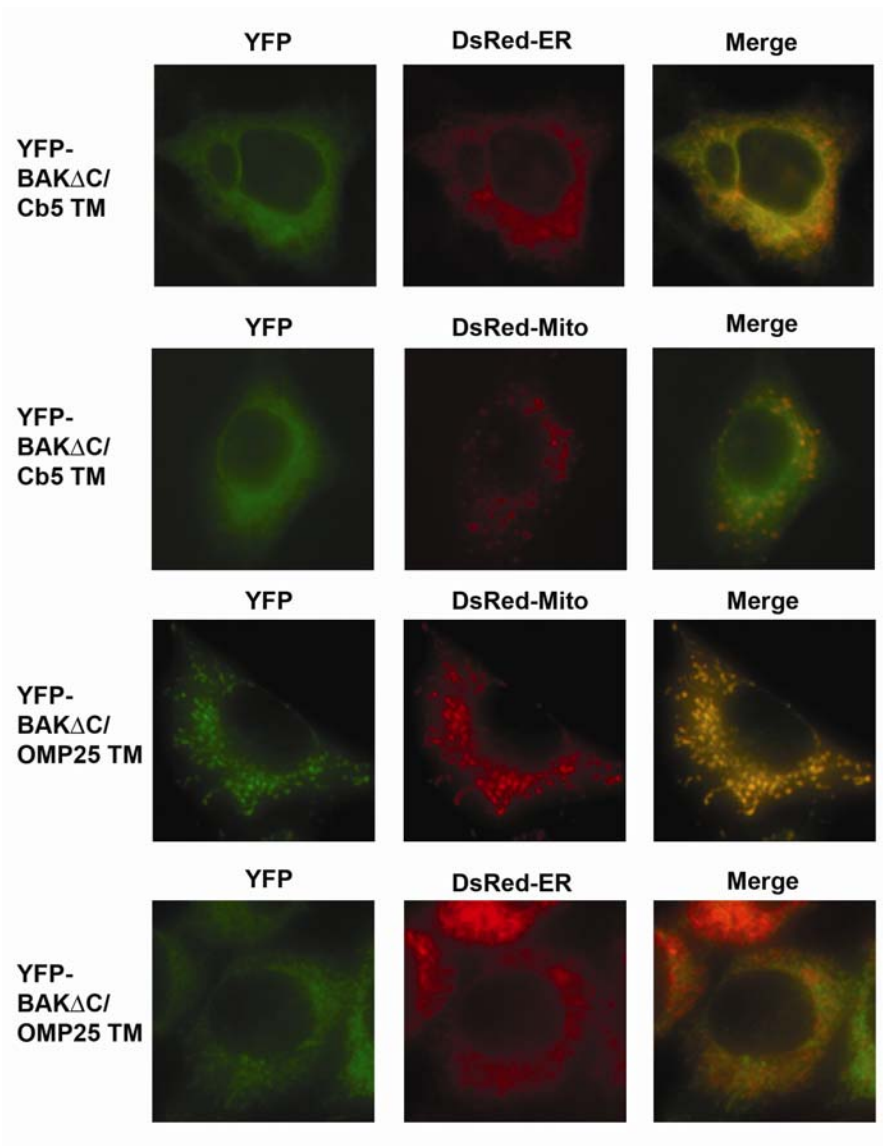
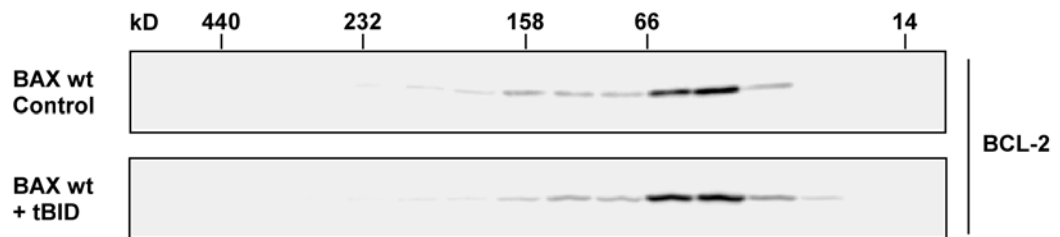
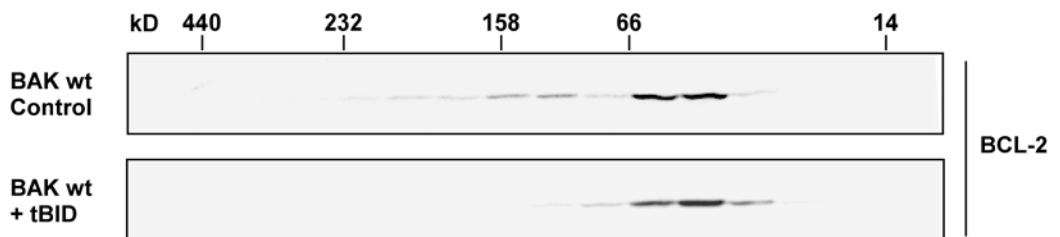

Figure S3.11

**A**



**B**



**- CHAPTER 4 -**

**BAK Triggers Mitochondrial Dysfunction by Inhibiting  
VDAC Activity upon Activation by BH3-only Molecules**

#### 4.1. Summary

Although activated BAX/BAK not only mediates cytochrome *c* release but also initiates caspase-independent mitochondrial dysfunction, the mechanism whereby BAX/BAK modulates mitochondrial physiology remains uncharacterized. Here, I identify a BAK complex that contains VDAC/ANT channels known to regulate ATP/ADP transport to support ATP production by oxidative phosphorylation. This higher-ordered BAK complex is functionally different from BAK oligomers that induce cytochrome *c* release during apoptosis. Activator BH3-only tBID is recruited to the complex and shuts down VDAC-mediated ADP import into the mitochondria in a BAK-dependent manner. Accordingly, knockdown of *Bak* inhibits the loss of ATP and cell death upon tBID overexpression in *Apaf-1*-deficient cells, suggesting that activated BAK antagonizes VDAC activity to initiate mitochondrial dysfunction. This study provides novel insights into how BAK promotes caspase-independent cell death and also suggests that BAK controls the metabolic function of VDAC, coupling apoptosis and mitochondrial physiology.

## 4.2. Introduction

Mitochondrion is a complex and versatile organelle that controls both life-supporting function and death-promoting activity (Newmeyer and Ferguson-Miller, 2003). Integration of apoptotic signals at the mitochondria is a critical determinant for mammalian cell death, which is controlled by BCL-2 family members (Danial and Korsmeyer, 2004). Upon apoptotic signals, multidomain proapoptotic BAX and BAK homo-oligomerize to permeabilize the mitochondrial outer membrane, releasing cytochrome *c* to initiate Apaf-1-dependent caspase activation, while anti-apoptotic BCL-2, BCL-X<sub>L</sub>, and MCL-1 protect mitochondrial membrane integrity (Youle and Strasser, 2008). BAX/BAK is activated by the third BCL-2 family, BH3-only molecules (BH3s) that either directly induce conformational change of BAX/BAK or occupy the pocket of anti-apoptotic BCL-2 members to prevent the sequestration of BH3s by anti-apoptotic BCL-2 members (Cheng et al., 2001; Certo et al., 2006; Kim et al., 2006). Since other apoptogenic factors are also compartmentalized in the intermembrane space of mitochondria, maintaining mitochondrial integrity is important to prevent programmed cell death (Green and Kroemer, 2004). On the other hand, mitochondrion is responsible for carrying out energy-yielding oxidative phosphorylation that generates ATP to maintain various cellular functions and mediating critical metabolic reactions that produce amino acids and lipids to sustain cell survival. Thus, regulation of mitochondrial physiology is also an important control point for cell death. The alteration of redox potential and accumulation of cellular oxidative stress by the generation of reactive oxygen species (ROS) accompanied by energy catastrophes also play a crucial role to



trigger mitochondrial dysfunction and cell death (Green and Reed, 1998). Numerous mitochondrial diseases due to the defects on both mitochondrial DNA- and nuclear DNA-encoded mitochondrial proteins involved in the electron transport and oxidative phosphorylation emphasize the central role of mitochondria in controlling energy metabolism and cellular homeostasis (Wallace and Fan, 2009).

Although BAX and BAK function as essential downstream effectors that control cytochrome *c*-dependent caspase activation by constituting pores at the mitochondrial outer membrane, several studies suggest that they are also involved in the cell death that occurs independently of caspase activity. BAX overexpression in Jurkat cells triggers cell death despite the inhibition of BAX-induced caspase activation (Xiang et al., 1996). Combination of BAX expression and F<sub>1</sub>F<sub>0</sub>-ATPase inhibitor oligomycin induces cell death in the presence of caspase inhibitor in GM701 cells, indicating that BAX may directly regulate mitochondrial physiology that maintains the cellular metabolic process including ATP production (Fitch et al., 2000). F<sub>1</sub>F<sub>0</sub>-ATPase was also shown to be functionally linked to BAX by the genetic study of BAX-induced killing in yeast (Matsuyama et al., 1998). In contrast, anti-apoptotic BCL-X<sub>L</sub> was shown to prevent mitochondrial hyperpolarization induced by oligomycin (Vander Heiden et al., 1997). Most importantly, we have previously showed that *Apaf-1*-deficient MEFs where cytochrome *c*-initiated caspase-dependent apoptotic cell death axis is eliminated slowly die upon overexpression of BH3s, whereas *Bax/Bak* DKO cells are completely resistant to BH3s (Cheng et al., 2001). The cell death is accompanied by the loss of mitochondrial transmembrane potential, suggesting that mitochondrial dysfunction plays a major role in executing cell death in *Apaf-1*-deficient cells. However, the mechanism by which BAX

and/or BAK regulate mitochondrial dysfunction upon activation by BH3s remains uncharacterized.

Mitochondrion serves as a critical site of cell survival regulation by generating cellular ATP through oxidative phosphorylation coupled with electron transport (Newmeyer and Ferguson-Miller, 2003). In order to maintain the electrochemical gradient generated by the electron flow along the electron transport chain machinery, ATP production from ADP by ATP synthase must be tightly coupled with continuous exchange of ATP/ADP across the mitochondrial membranes. Limited substrate availability for ATP synthase would lead to inner membrane hyperpolarization due to the accumulation of proton gradient in the intermembrane space, increased production of ROS, and dissipation of transmembrane potential, culminating in mitochondrial dysfunction and cell death. Voltage-dependent anion channel (VDAC) is a pore-forming channel found in the mitochondrial outer membrane of all eukaryotes that is known to regulate ATP/ADP transport and metabolite fluxes such as creatine phosphate, succinate, and pyruvate between cytosol and intermembrane space (Colombini et al., 1996; Hodge and Colombini, 1997). VDAC interacts with proteins in the intermembrane space and adenine nucleotide translocator (ANT) in the inner membrane, which leads to the formation of the 'contact sites' between the mitochondrial outer membrane and the peripheral inner membrane (Crompton et al., 2002). This tight coupling of VDAC and ANT channels allows for regulating the activity of oxidative phosphorylation by substrate exchange such as ADP to adjust mitochondrial function (Brdiczka et al., 2006). Of note, VDAC channel dysfunction by adopting its closed conformation has been implicated in cell death triggered by growth factor withdrawal, which disrupts the ATP/ADP transport

causing mitochondrial hyperpolarization and dysfunction (Vander Heiden et al., 1999; Vander Heiden et al., 2000). There exist three VDAC isoforms in mammals, which exhibit a considerable degree of functional redundancy regarding the metabolic function of mitochondria (Wu et al., 1999). However, contrary to viable *Vdac1* or *Vdac3* null mice, *Vdac2* deficiency causes embryonic lethality likely due to the unchecked activation of its binding partner BAK to trigger apoptosis (Cheng et al., 2003). The physical association between the proapoptotic molecule and the regulator of mitochondrial physiology raises the possibility that BAK may have a reciprocal activity to modulate the VDAC-mediated metabolic function following cell death signals. However, the regulation of VDAC function by BAK has not been investigated yet.

Here, I demonstrate that BAK negatively regulate VDAC-mediated ATP/ADP transport leading to mitochondrial dysfunction upon activation by BH3s. Biochemical analyses demonstrated that BAK constitutes a higher-ordered complex associated with VDAC/ANT channels likely localized at the contact sites. In contrast to BAK oligomers formed by tBID-induced activation, this BAK complex is not able to induce cytochrome *c* release but instead modulates the preexisting VDAC/ANT channel activity. *Apaf-1*-deficient cells with *Bak* downregulation exhibit higher level of cellular ATP by maintaining greater ability to import ADP into the mitochondria through VDAC channels, rendering cells less susceptible to tBID-induced cell death. tBID is recruited to the BAK/VDAC/ANT complex, but requires BAK to kill cells. This study not only provides novel insights into how BAK triggers caspase-independent mitochondrial dysfunction, but also presents solid biochemical evidence that BAK exerts its distinct prodeath roles through different BAK complexes at the mitochondria. In addition, the result implies that

in mammals, BAK and VDAC2 may have coevolved to reciprocally regulate their functions to control both apoptosis and mitochondrial dysfunction.

### **4.3. Materials and Methods**

#### **Plasmid Construction and Retrovirus Production**

The production of retrovirus and retroviral transduction of Protein C-HA-Flag BAK to *Bax/Bak* DKO MEFs were performed as previously described (Cheng et al., 2001; Kim et al., 2006). The tBID-inducible *Apaf-1* knockout MEFs were generated by Ho-Chou Tu at our laboratory.

#### **Cell culture and viability assay**

All the mouse embryonic fibroblasts (MEFs) utilized were SV-40 transformed and maintained in Dulbecco's Modified Eagles Medium supplemented with 10% fetal bovine serum following standard culture conditions and procedures. Cell death was quantified by propidium iodide (Sigma; 2 µg/mL) staining followed by flow cytometric analysis using a FACSCaliber (BD Biosciences) and CellQuest Pro Software.

#### **Knockdown experiments**

Retrovirus-mediated shRNA knockdown constructs were generated using pSuperior-Retro-Puro according to the manufacture's instruction (Oligoengine). The murine targeting sequences are as follows: *Bax* 5'-CACCAAGAAGCTGAGCGAG, *Bak* 5'-TATTAACCGGCGCTACGAC, *Luciferase* shRNA, 5'-GCGCGCTTTGTAGGA-TTCG. For siRNA-mediated knockdown, following Ambion *Silencer* Select oligos (Applied Biosystems) were reverse-transfected using lipofectamine RNAiMAX (Invitrogen) to a final concentration of 10 nM for 2 days before experiments; *Bax* #1 5'-

CUUCUACUUUGCUAGCAAAtt, *Bax* #2 5'-GGAUGAUUGCUGACGUGGAtt, *Bak* #1 5'-CCUACGAACUCUCUACCAAtt, *Bak* #2 5'-GAAUUUACUAGAACAGCUUtt.

### **Antibodies, reagents and Western blot**

BH3 peptides of BIM (MRPEIWIAQELRRIGDEFNA) were synthesized by Tufts University Core Facility (Boston, MA). The primary antibodies used for Western blots are listed as followed: anti-BAX (N20, Santa cruz), anti-BAK (NT, upstate), anti-VDAC1 (Porin 31HL, Calbiochem), anti-VDAC2 (rabbit polyclonal; peptide of amino acid 212-228), anti-prohibitin 2 (Upstate), anti-cyclophilin D (Affinity BioReagents), anti-ATP synthase  $\beta$  (BD Biosciences), anti-cytochrome *c* oxidase IV (Cell Signaling), anti-BID (Wang et al., 1996), anti-actin (Chemicon). Cellular and mitochondrial lysates were separated by NuPAGE (Invitrogen) or SDS-PAGE (Bio-Rad) gels and transferred onto PVDF membrane (Immobilon-P; Millipore). Antibody detection was accomplished by enhanced chemiluminescence method (Western Lightning, PerkinElmer) and LAS-3000 Imaging system (FUJIFILM).

### **Identification of the mitochondrial BAK complex**

Mitochondria isolation was performed as previously described (Cheng et al., 2001). Mitochondria isolated from *Bax/Bak* DKO MEFs or DKO MEFs expressing Protein C-Flag-HA tagged BAK were left untreated or treated with 10  $\mu$ M of BIM BH3 peptide and lysed with 1 % CHAPS lysis buffer (1 % CHAPS, 142.5 mM KCl, 2 mM CaCl<sub>2</sub>, 20 mM Tris-Cl, pH 7.4) supplemented with EDTA-free protease inhibitor (Roche). After centrifugation, the supernatant was removed, and the pellet was sonicated in lysis

buffer with 2 % CHAPS supplemented with EDTA-free protease inhibitor (Roche), and the supernatant was designated as 1 % CHAPS insoluble / 2 % CHAPS soluble mitochondrial fraction. The protein lysates were immunoprecipitated by anti-Protein C affinity matrix (Roche) overnight and eluted with 10 mM EDTA after three times of washing. The eluted immune complex was precipitated by trichloroacetic acid and analyzed by 4-12 % MOPS NuPAGE (Invitrogen) gel and silver staining (Silver Staining Plus kit, Bio-Rad). Excised gel slices of interest were sent for tandem mass spectrometric analysis at Taplin Mass Spectrometry Facility (Harvard Medical School, Boston, MA).

### **Gel filtration chromatography and immunoprecipitation**

The chromatographic step of Superdex 200 (HR 10/30, GE-Amersham) was performed on an automatic fast protein liquid chromatography (AKTApurifier, GE-Amersham) as previously described (Cheng et al., 2003). The column was equilibrated with 2 % CHAPS gel filtration buffer (2 % CHAPS, 300 mM NaCl, 0.2 mM DTT, 20 mM HEPES pH 7.5) and calibrated with thyroglobulin (669 kD), ferritin (440 kD), catalase (232 kD), aldolase (158 kD), bovine serum albumin (66 kD), and cytochrome *c* (14 kD). Mitochondrial lysates were loaded onto the column, eluted at a flow rate of 0.3 ml/min. Fractions of 0.6 ml were collected, precipitated by trichloroacetic acid, and analyzed by 8-16 % SDS-PAGE (Bio-Rad) gels and Western blots. For immunoprecipitation of Protein C-HA-Flag tagged BAK from gel filtration eluants, the indicated fractions were combined and incubated with anti-Protein C beads in the presence of 2 mM Ca<sup>2+</sup> supplemented with EDTA-free protease inhibitor (Roche). The samples

were separated by 4-12 % MOPS NuPAGE (Invitrogen) gels and analyzed by silver staining and Western blots.

### **Cytochrome *c* release and cross-linking**

The aliquots of gel filtration fractions were incubated with *Bax/Bak* DKO mitochondria such that the final CHAPS concentration is less than 0.1 % in 1 mg/mL (100  $\mu$ l) of mitochondria. Quantitation of cytochrome *c* release was performed using colorimetric ELISA assays as previously described (MCTC0; R&D Systems; Kim et al., 2006). For detecting BAK oligomers, bismaleimido-hexane (BMH; Pierce) was directly added to the elution fractions at the final concentration of 2.5 mM, incubated at room temperature for 30 min, and quenched by NuPAGE sample buffer. The samples were analyzed by 4-12 % NuPAGE and anti-BAK Western blot.

### **Measurement of cellular ATP and ADP levels**

Cellular ATP levels were measured by the luciferin/luciferase method using ATP Bioluminescence Assay Kit HS II (Roche). The total  $10^4$  MEFs were used for each assay. Upon automatic injection of 50  $\mu$ l of luciferase reagents to 50  $\mu$ l of diluted samples, the luminescence signal was integrated for 10 sec after a delay of 1 sec using a Dynex MLX 96-well Plate Luminometer (MTX Lab Systems, Inc). A standard curve was prepared for each measurement by serial dilutions of ATP standard provided by the kit. For ADP measurement, ADP in the lysates was first converted to ATP by adding 4 mM phospho(enol)pyruvate (Sigma) and 5 U of pyruvate kinase (Sigma) in 0.1 M phosphate buffer, and the ATP + ADP value was determined. Then, ATP value of the same lysate



was determined, which was subtracted from the ATP + ADP value to acquire the ADP value.

#### **ANT-dependent ADP import assay**

Mitochondrial pellets were resuspended with 900  $\mu$ l of ADP import buffer (250 mM sucrose, 20 mM HEPES, 10 mM KCl, 5 mM succinate, 3 mM  $\text{KH}_2\text{PO}_4$ , 1.5 mM  $\text{MgCl}_2$ , 1 mM EGTA, 5  $\mu$ M rotenone pH 7.2). For 400  $\mu$ l of mitochondrial resuspension, 50  $\mu$ M of atractyloside (Sigma) was pretreated before incubating with 0.5  $\mu$ Ci of  $^{14}\text{C}$ -ADP (PerkinElmer NEN<sup>®</sup> radiochemicals) for 10 min on ice. The reaction was stopped by adding 700  $\mu$ l of ADP import buffer containing 50  $\mu$ M of atractyloside. After centrifugation, the pellets were washed twice with ADP import buffer, and  $^{14}\text{C}$ -ADP counts were determined by liquid scintillation counter (LS6000; Beckman coulter). ANT-specific ADP uptake was calculated by subtracting the counts of the sample pretreated with atractyloside from the untreated one. To isolate mitoplasts, 0.5 mg/mL of purified mitochondria was treated with 0.15 % (w/v) digitonin (Sigma) in mitoplast isolation buffer (220 mM mannitol, 70 mM sucrose, 2 mM HEPES pH 7.5) for 10 min on ice and spun down at 10,000 g for 10 min. *P* values for statistical analyses were obtained using Student's *t* test.

## 4.4. Results

### *BAK associates with VDAC/ANT channels*

To address the question if there are additional proteins associated with BAK to facilitate cytochrome *c* release, I initially attempted to identify the BAK complex that constitutes a pore to release cytochrome *c*. Given that BAK is an integral mitochondrial membrane protein that may be resistant to the certain level of detergent, mitochondrial fraction was prepared by removing 1 % CHAPS soluble fraction and dissolving the remaining pellet in 2 % CHAPS with sonication. From this 1% CHAPS insoluble / 2% CHAPS soluble mitochondrial lysate derived from *Bax/Bak* DKO MEFs reconstituted with Protein C-HA-Flag-tagged BAK, anti-Protein C affinity purification was performed. BIM BH3 domain peptide that can induce BAK activation was incubated with mitochondria in order to see the different protein profiles before and after death stimuli (Letai et al., 2002). Unexpectedly, tandem mass spectrometry identified VDAC1, VDAC2, VDAC3, ANT1 and prohibitin 2 as BAK-associated proteins, and the composition was not changed after addition of BIM peptide (Fig. 4.1A). Specific interactions were verified by anti-Protein C immunoprecipitation and Western blot analyses (Fig. 4.1B). On the other hand, neither matrix protein cyclophilin D nor mitochondria innermembrane protein ATP synthase  $\beta$  was pulled down with BAK, confirming the specificity of the interaction (Fig. 4.1B). These data suggest that BAK associates with the VDAC/ANT channel complex present at the contact sites that can be extracted by relatively high concentration of CHAPS. VDAC and ANT presumably concentrated at the contact sites were previously shown to be co-purified with

mitochondrial kinases or receptors from a Triton X-100 extract of rat brain or kidney homogenates (Beutner et al., 1996; McEnery et al., 1992)

***BAK exists as three distinct complexes at the mitochondria***

The identification of a BAK complex from nonapoptotic cells suggests that BAK is able to form a complex other than the BAK-mediated pore formed during apoptosis, which can be extracted by different concentration of detergent. Therefore, I performed gel filtration chromatography using 1 % CHAPS soluble or 1 % CHAPS insoluble / 2 % CHAPS soluble mitochondrial lysates to assess the existence of different BAK complexes. Interestingly, it showed different elution patterns of BAK depending on the detergent concentration and the treatment of activator BH3 tBID that induces oligomerization of BAK (Wei et al., 2000; Cheng et al., 2003; Kim et al., 2006). BAK exists as a presumably inactive form around 60 kD in the 1 % CHAPS soluble fraction and appeared between 150 and 200 kD in response to tBID (Fig. 4.2A). This corresponds to the size of oligomeric BAK presumably composed of 6 to 8 BAK molecules, suggesting that this may represent the cytochrome *c*-releasing BAK oligomeric pores formed after BAK activation. In contrast, BAK was eluted in the high molecular weight fractions around 500 kD as well as 60 kD in the 1 % CHAPS insoluble / 2 % CHAPS soluble mitochondrial fraction prior to tBID addition (Fig. 4.2A). tBID treatment reduced the 60 kD BAK and induced the formation of 160 kD BAK complex (Fig. 4.2A). Of note, BAK was present around 500 kD before and after tBID treatment (Fig. 4.2A). The discovery of a high molecular weight BAK complex around 500 kD before activation

raises the possibility that BAK may exert distinct function at the mitochondria other than inducing cytochrome *c* release during apoptosis.

***The 500 kD BAK complex is functionally distinct from the 160 kD BAK complex***

To determine whether the components identified as BAK-associated proteins constitute the 500 kD BAK complex revealed by gel filtration, I collected these fractions from gel filtration of the 1 % CHAPS insoluble / 2 % CHAPS soluble mitochondrial lysates and performed anti-Protein C affinity purification. Silver staining and Western blot analyses showed that the identified proteins were co-precipitated with BAK (Fig. 4.2B). Of note, the identified proteins were also eluted in the high molecular weight fractions, indicating that these proteins constitute a higher-ordered complex with BAK (Fig. 4.2C). This association is not due to the insufficient detergent solubilization of mitochondrial inner membranes, since inner membrane protein cytochrome *c* oxidase IV and ATP synthase  $\beta$  exhibit distinct elution profiles different from those of BAK-associated proteins (Fig. 4.2C). Moreover, matrix protein cyclophilin D known to regulate  $\text{Ca}^{2+}$ - and ROS-induced necrotic cell death through the permeability transition pore did not co-elute with BAK (Baines et al., 2005; Nakagawa et al., 2005) (Fig. 4.2C). In stark contrast, BAK from the ~ 160 kD fraction that appeared after tBID treatment was not associated with any other protein, implicating that the oligomeric BAK by itself may be sufficient to form pores that can release cytochrome *c* (Fig. 4.2D). Indeed, BAK from the ~ 160 kD fraction could be cross-linked to produce dimer and trimer, and release cytochrome *c* from *Bax/Bak* DKO mitochondria whereas BAK from the 500 kD complex

or the 60 kD BAK could not (Fig. 4.2E and 2F). These data suggest that the 160 kD BAK complex and the 500 kD BAK complex are functionally distinct.

Next, I asked whether BAK is essential for the formation of the 500 kD complex, or BAK is recruited to the pre-existing VDAC/ANT complex to modulate its function. VDAC isoforms and prohibitin 2 were still eluted in the high molecular weight fractions in the absence of BAX and BAK, suggesting that BAK is not essential for the formation of the higher-ordered complex (Fig. 4.2G). Instead, this suggests that BAK is recruited to the VDAC/ANT complex localized at the contact sites.

#### ***BAK inhibits VDAC-mediated ATP/ADP transport upon activation by BH3s***

Since BAK is known to mediate mitochondrial dysfunction triggered by BH3s (Cheng et al., 2001), and my result suggests that it associates with VDAC and ANT that constitute essential channels for ATP/ADP transport, I hypothesized that BAK negatively regulates the VDAC channel activity leading to mitochondrial dysfunction upon activation by BH3s. VDAC channel dysfunction has been shown to be correlated with mitochondrial dysfunction and cell death where removal of growth factor resulted in the failure of VDAC channels to maintain ATP/ADP transport (Vander Heiden, et al., 1999; Vander Heiden, et al., 2000). To determine if BAK antagonizes the VDAC channel activity leading to the failure of ATP generation, cellular ATP level during tBID-induced cell death was measured. The ATP level of *Apaf-1*-deficient cells significantly decreased upon tBID expression, whereas *Bax/Bak* DKO cells maintained their initial ATP level (Fig. 4.3A). The other activator BH3s, BIM and PUMA could also deplete the cellular ATP level (Fig. 4.3B). The decline of ATP level was not the secondary effect of cell

death since cell death was minimal at the time point when ATP was already significantly depleted (Fig. 4.3C). Moreover, ATP decrease was accompanied by an increase of cellular ADP level excluding the possibility that ATP loss is due to the overall decrease of ADP substrate for ATP production (Fig. 4.3D). Importantly, *Apaf-1*-deficient cells with *Bak* downregulation maintained their higher ATP level compared to control upon tBID overexpression, suggesting that BAK antagonizes the continuous ATP production when it is activated by tBID (Fig. 4.3E).

To provide direct evidence that mitochondrial dysfunction occurs due to the defect of ATP/ADP transport through the mitochondria, the ability of mitochondria to uptake ADP through VDAC/ANT channels was measured upon activation of BAK by BH3s. To acquire synchronized and homogenous tBID expression from a large amount of cells, a tBID-inducible system in the *Apaf-1*-deficient MEFs was established by Ho-Chou Tu at our lab. This inducible system is created by a retroviral insertion of the GFP coding sequence flanked by LoxP in the upstream of tBID cDNA under the same LTR promoter such that 4-hydroxytamocifen (4-OHT) treatment can activate Cre-ERT2 and remove the GFP sequence to induce tBID expression. tBID induction was confirmed by Western blot (Fig 4.3F). Treatment of 4-OHT almost completely inhibited the ability of mitochondria to import ADP when cell death was not evident (Fig. 4.3F, G). The parental *Apaf-1*-deficient cells treated with 4-OHT had no such defect verifying the specific effect of tBID expression (Fig. 4.3H). Of note, mitochondria isolated from the cells with *Bak* downregulation following 4-OHT treatment exhibited greater ability to import ADP than control mitochondria, arguing that BAK is required to inhibit ADP transport through VDAC/ANT channels upon activation by BH3s (Fig. 4.3G). To examine whether

defective ADP import is due to the inhibition of ADP transport across the outer membrane caused by VDAC channel dysfunction, mitoplasts were isolated by removing the mitochondrial outer membrane. The mitoplasts from tBID-expressing *Apaf-1*-deficient cells had intact ability to uptake ADP in contrast to whole mitochondria, suggesting that the dysfunction of VDAC, but not that of ANT is responsible for the defect of ADP import upon tBID expression (Fig. 4.3I).

***tBID is recruited to the VDAC/ANT complex, but requires BAK to induce mitochondrial dysfunction and cell death***

Consistent with the role of BAK in triggering the defect of VDAC-mediated ADP transport, shRNA-mediated *Bak* downregulation significantly protected *Apaf-1*-deficient cells against tBID-induced cell death, while *Bax* downregulation had minimal effect (Fig. 4.4A). Knockdown by siRNA oligos showed similar results (Fig. 4.4B).

Given that the components of the 500 kD BAK complex do not change before and after BH3 treatment (Fig. 4.1A.), it is plausible that BH3s is recruited to the complex and triggers VDAC channel dysfunction in a BAK-dependent manner. Indeed, tBID treated to the isolated mitochondria was eluted in the high molecular weight fractions in the gel filtration of the 1% CHAPS insoluble / 2 % soluble mitochondrial lysates (Fig. 4.4C). This is consistent with the previously reported *in vitro* study, which demonstrated that recombinant tBID is able to induce irreversible VDAC channel closure (Rostovtseva et al., 2004). Taken together, these results suggest that BH3s are recruited to the BAK/VDAC/ANT complex but requires BAK to initiate VDAC channel dysfunction.

## 4.5. Discussion

Mitochondrion serves as an important control point for both apoptotic and nonapoptotic cell death regulated by BCL-2 family members (Green and Kroemer, 2004). Although BAK activated by upstream death signals is known to disrupt mitochondrial outer membrane integrity, triggering cytochrome *c*-initiated caspase activation, whether activated BAK affects the metabolic state of mitochondria to augment cellular demise is not clear. Here, I demonstrate that BAK associates with VDAC/ANT channels at the contact sites to negatively regulate the ATP/ADP transport through VDAC to trigger mitochondrial dysfunction upon activation by BH3s. This BAK complex is functionally distinct from the cytochrome *c*-releasing BAK oligomeric pore at the mitochondrial outer membrane. Therefore, BAK probably forms two distinct prodeath complexes at the mitochondria (Fig. 4.5). One is localized at the mitochondrial outer membrane, but kept in check by direct interaction with VDAC2 isoform. Upon activation by BH3s, BAK is released from VDAC2 to undergo homo-oligomerization to release cytochrome *c*. This complex at the mitochondrial outer membrane can be extracted by 1 % CHAPS. The other is localized at the contact sites, where BAK is associated with VDAC/ANT channels that regulate ATP/ADP transport. By coupling VDAC that allows diffusion of small molecules into the intermembrane space with ANT that is selectively permeable to a few ions and metabolites into the matrix, the contact sites provide both structural and functional basis for adjusting mitochondrial function to the energy demand and regulatory signals (Brdiczka, 2007). This junctional complex is more resistant to detergent extraction compared to the one at the mitochondrial outer membrane as



revealed by gel filtration analysis. Importantly, BAK is required for tBID to shut down the VDAC-mediated ATP/ADP transport, which triggers uncoupling of oxidative phosphorylation and electron transport, ultimately causing mitochondrial dysfunction. Therefore, upon receipt of cell death signals, BAK exerts its prodeath role both by triggering cytochrome *c*-initiated caspase activation and by mediating VDAC channel dysfunction, via utilizing two distinct complexes. The biochemical characterization of the complex presented here supports the role of BAK in regulating mitochondrial proteins at the contact sites, thereby integrating cell death signals and mitochondrial physiology.

This study exemplifies the existence of the cell death program that can occur independently of caspase activation. It is known that although Apaf-1 functionally couples mitochondria and caspase activation by sensing the released cytochrome *c* in the cytosol to execute apoptosis, perturbation of mitochondria physiology also triggers nonapoptotic cell death without caspase activation. However, this process is heavily dependent on the upstream BCL-2 family members. For instance, *Apaf-1*-deficient ES cells undergo cell death with the loss of mitochondrial membrane potential, which is rescued by BCL-2 overexpression, indicating that BAX/BAK activation and/or mitochondrial membrane permeabilization mediates caspase-independent cell death upstream of Apaf-1 (Haraguchi et al., 2000). In addition, *Bax/Bak* DKO mice exhibit much more severe phenotypes than *Apaf-1* or *caspase-9* knockout mice; deletion of *Apaf-1* slows but does not inhibit the loss of interdigital web during development, which is completely blocked in *Bax/Bak* DKO background (Lindsten et al., 2000; Yoshida et al., 1998).

I showed that VDAC is a key target in BAK-induced mitochondrial dysfunction. However, the mechanism by which VDAC channel dysfunction is caused by BAK remains to be understood. BCL-X<sub>L</sub> was demonstrated to inhibit growth factor withdrawal-induced cell death by promoting the open configuration of VDAC thereby maintaining the balance of metabolic flux (Vander Heiden et al., 2001). Since BAK is associated with VDAC/ANT channels in the absence of death stimuli, and tBID requires BAK to kill cells, activation of BAK by BH3s may induce conformational change of BAK that directly alters the gating property of VDAC channels. The recently solved VDAC1 structure suggests that the movement of an N-terminal  $\alpha$ -helix into the pore with substantial conformational flexibility may contribute to the channel gating such that the close state of VDAC is impermeable to negatively charged metabolites such as ATP/ADP (Bayrhuber et al., 2008; Hiller et al., 2008; Ujwal et al., 2008). Alternatively, activated form of BAK may change local lipid environment to alter the gating property of VDAC indirectly. Interestingly, it was reported that tBID induces negative membrane curvature and destabilization of bilayer membranes, suggesting that the insertion of a BCL-2 family protein to membranes can directly affect the membrane properties (Epanand et al., 2002)

Mitochondrial outer membrane permeabilization by activated BAK causes the redistribution of cytochrome *c* from the electron transport chain machinery, which is expected to inhibit respiration. However, block of the respiration by the loss of cytochrome *c* cannot fully explain mitochondrial dysfunction since tBID-induced respiratory failure can only be partially rescued by exogenous cytochrome *c* at early time points, which progressively becomes irreversible (Mootha et al., 2001). My study implies that the inability for VDAC/ANT channels to maintain ATP/ADP transport caused by

BAK activation leads to the decreased activity of ATP synthase due to the limited substrate availability, which causes the arrest of electron flow in the electron transport chain. This would allow the elevated level of ROS generation and dissipation of transmembrane potential ultimately causing mitochondrial dysfunction. Therefore, BAK activation by BH3s results in engaging two distinct pathways to ensure cell death-caspase activation and mitochondrial dysfunction.

In addition to functioning as a channel, VDAC2 has evolved to keep lethal BAK in check by its direct interaction with BAK at the mitochondrial outer membrane (Cheng et al., 2003). My study suggests that BAK has also acquired its additional prodeath role by controlling VDAC/ANT-mediated ATP/ADP transport. This reciprocal regulation would allow the sophisticated coupling of mitochondrial physiology and apoptosis by activated BAK.

#### 4.6. Figure Legends

##### **Figure 4.1. BAK associates with the VDAC/ANT complex that can be extracted by high concentration of CHAPS detergent**

(A) VDAC isoforms, ANT1, and prohibitin2 are identified as BAK-associating proteins at the mitochondria. The 1 % CHAPS insoluble / 2 % CHAPS soluble mitochondrial lysates from *Bax/Bak* DKO MEFs reconstituted with protein C-HA-Flag BAK with or without treatment of BIM BH3 peptides was subjected to anti-protein C affinity column followed by EDTA elution, and the specific bands from silver staining was analyzed by tandem mass spectrometry. The mitochondrial lysate from *Bax/Bak* DKO MEFs serves as a negative control.

(B) VDAC isoforms, ANT1, and prohibitin2 are associated with BAK. Immunoprecipitates prepared as described above were analyzed by 4-12 % NuPAGE and Western blots using the indicated antibodies.

##### **Figure 4.2. BAK constitutes functionally distinct complexes at the mitochondria**

(A) BAK constitutes three different complexes determined by gel filtration. Wild-type mitochondria left untreated or treated with recombinant tBID (1 ng/ $\mu$ l) was solubilized with the indicated concentration of CHAPS and the protein lysates were subjected to Superdex 200 (HR 10/30) gel filtration chromatography. The fractions were analyzed by 8-16 % SDS-PAGE and anti-BAK Western blot.

(B) The identified proteins are associated with BAK at the high-molecular weight fractions. The 1 % CHAPS insoluble / 2 % CHAPS soluble mitochondrial lysates were

isolated from *Bax/Bak* DKO MEFs reconstituted with protein C-HA-Flag BAK and were subjected to Superdex 200 (HR 10/30) gel filtration chromatography. The high-molecular weight fractions were collected and immunoprecipitated with anti-Protein C-conjugated beads followed by silver staining and Western blot analyses using the indicated antibodies. Asterisks denote the two bands that match with those in Fig. 4.1A.

(C) The identified proteins are co-eluted with BAK in the high-molecular weight fractions. The 1 % CHAPS insoluble / 2 % CHAPS soluble mitochondrial lysates were prepared from wild-type MEFs and were subjected to Superdex 200 (HR 10/30) gel filtration chromatography. The fractions were analyzed by Western blot analyses using the indicated antibodies.

(D) No associated proteins are identified in the 160 kD BAK complex. Mitochondria isolated from *Bax/Bak* DKO MEFs reconstituted with protein C-HA-Flag BAK were treated with recombinant tBID (1 ng/ $\mu$ l) and solubilized in 1 % CHAPS buffer. The protein lysates were subjected to Superdex 200 (HR 10/30) gel filtration chromatography. The indicated 160 kD fractions were collected and immunoprecipitated with anti-Protein C-conjugated beads followed by silver staining.

(E) The BAK in the 160 kD fractions form oligomers. The fractions eluted at ~500 kD, ~160 kD, or ~60 kD from the gel filtration chromatography of wild-type mitochondrial lysates as described in Fig. 4.2A were incubated with 2.5 mM BMH, separated by 4-12 % NuPAGE and analyzed by anti-BAK Western blot.

(F) The 160 kD BAK complex is able to release cytochrome *c*. The fractions eluted at ~500 kD, ~160 kD, or ~60 kD from the gel filtration chromatography were incubated with 0.5 mg/mL of *Bax/Bak* DKO mitochondria. Cytochrome *c* release from the

mitochondria was quantified by ELISA assays. The cytochrome *c* release activity was normalized against the background release by buffer alone.

(G) BAK is not required for the formation of the higher-ordered complex. The 1 % CHAPS insoluble / 2 % CHAPS soluble mitochondrial lysates were prepared from *Bax/Bak* DKO MEFs and were subjected to Superdex 200 (HR 10/30) gel filtration chromatography. The fractions were analyzed by Western blot analyses using the indicated antibodies.

**Figure 4.3. BAK is required for shutting down VDAC activity upon tBID expression**

(A) Cellular ATP decreases upon tBID expression in *Apaf-1*-deficient cells. Cell extracts were prepared from the equal numbers of *Apaf-1* KO or *Bax/Bak* DKO MEFs transduced with control retrovirus (MIGII) or retrovirus expressing tBID for the indicated times, and the ATP levels were measured using the luciferin/luciferase method. Data shown are mean  $\pm$  s.d. from three independent experiments.

(B) Cellular ATP decreases upon BIM or PUMA expression. Cell extracts were prepared from the equal numbers of *Apaf-1* KO or *Bax/Bak* DKO MEFs transduced with control retrovirus (MIGII) or retrovirus expressing BIM or PUMA for 30 hrs, and the ATP levels were measured using the luciferin/luciferase method. Data shown are mean  $\pm$  s.d. from three independent experiments.

(C) The decrease of ATP level occurs prior to evident cell death. *Apaf-1* KO or *Bax/Bak* DKO MEFs were transduced with control retrovirus (MIGII) or retrovirus expressing tBID, and cell death was quantified by flow cytometric analysis of PI staining at 36 hrs. Data shown are mean  $\pm$  s.d. from three independent experiments.

(D) Cellular ADP increases upon tBID expression. Cell extracts were prepared from the equal numbers of *Apaf-1* KO or *Bax/Bak* DKO MEFs transduced with control retrovirus (MIGII) or retrovirus expressing tBID for 36 hrs. Total ADP + ATP level was determined after ADP was converted to ATP using pyruvate kinase and phospho(enol)pyruvate. The ATP level was measured from the same lysate, and it was subtracted from the ADP + ATP level to determine the net ADP level. Data shown are mean  $\pm$  s.d. from three independent experiments. Asterisk,  $P < 0.05$

(E) Downregulation of BAK inhibits the decrease of ATP caused by tBID expression. *Apaf-1*-deficient MEFs expressing shRNA against *luciferase* or *Bak* were transduced with control retrovirus (MIGII) or retrovirus expressing tBID for 24 hrs, and the ATP levels were measured using the luciferin/luciferase method. Data shown are mean  $\pm$  s.d. from three independent experiments. Asterisk,  $P < 0.05$

(F) tBID is induced upon treatment of 4-OHT. tBID-inducible *Apaf-1*-deficient MEFs with or without 500 nM of 4-OHT for 24 hrs were lysed and analyzed by anti-BID Western blot. At 24 hrs, cell death was not evident as quantified by flow cytometric analysis of PI staining.

(G) Mitochondria with *Bak* knockdown retain higher ability to import ADP upon tBID expression. Mitochondria were isolated from tBID-inducible *Apaf-1*-deficient MEFs expressing shRNA against *luciferase* or *Bak* with or without 4-OHT for 17 hrs.  $^{14}\text{C}$ -ADP uptake was measured in the absence or presence of atractyloside. The ANT-dependent  $^{14}\text{C}$ -ADP import to mitochondria from cells treated with 4-OHT is presented as a percentage of that measured from cells without 4-OHT. Data shown are mean  $\pm$  s.d. from three independent experiments. Asterisk,  $P < 0.05$

(H) 4-OHT treatment alone does not affect the ability for mitochondria to import ADP.

Mitochondria were isolated from *Apaf-1*-deficient MEFs left untreated or treated with 4-OHT for 24 hrs, and  $^{14}\text{C}$ -ADP uptake was measured with or without pretreatment of atractyloside. Data shown are mean  $\pm$  s.d. from three independent experiments.

(I) Mitoplasts retain the ability to import ADP upon tBID expression. Mitochondria were isolated from tBID-inducible *Apaf-1*-deficient MEFs expressing shRNA against *luciferase* or *Bak* with or without 4-OHT for 17 hrs.  $^{14}\text{C}$ -ADP uptake was measured in the absence or presence of atractyloside. Where indicated, mitoplasts were isolated by removing the mitochondrial outer membrane with 0.15 % digitonin, and the ANT-dependent  $^{14}\text{C}$ -ADP uptake by mitochondria or mitoplasts was assessed as (G). Data shown are mean  $\pm$  s.d. from three independent experiments. Asterisk,  $P < 0.05$

**Figure 4.4. tBID is recruited to the VDAC/ANT complex, but requires BAK to kill cells**

(A) shRNA-mediated *Bak* knockdown protects cells from tBID-induced cell death. *Apaf-1*-deficient MEFs expressing shRNA against *luciferase*, *Bax*, or *Bak* were transduced with retrovirus expressing tBID, and cell death was quantified by flow cytometric analysis of PI staining at the indicated times. Data shown are mean  $\pm$  s.d from three independent experiments. Anti-BAX/BAK Western blot confirms the efficient knockdown.

(B) siRNA-mediated *Bak* knockdown protects cells from tBID-induced cell death. tBID-inducible *Apaf-1*-deficient MEFs transfected with 10 nM of scramble siRNA, siRNA against *Bax* or siRNA against *Bak* for 48 hrs were treated with 500 nM of 4-



hydroxytamocifen (4-OHT), and cell death was quantified by flow cytometric analysis of PI staining at 51 hrs. Data shown are mean  $\pm$  s.d. from three independent experiments. Anti-BAX/BAK Western blot confirms the efficient knockdown.

(C) tBID is recruited to the higher-ordered BAK complex. Wild-type or *Bax/Bak* DKO mitochondria were incubated with tBID (1 ng/ $\mu$ l) and the 1 % CHAPS insoluble / 2 % CHAPS soluble mitochondrial lysates were subjected to Superdex 200 (HR 10/30) gel filtration chromatography. The fractions were analyzed by anti-BAK or anti-BID Western blot.

**Figure 4.5. Schematic depicts the dual role of BAK in mediating both cytochrome *c*-dependent caspase activation and mitochondrial dysfunction**

4.7. Figures

Figure 4.1.

**A**

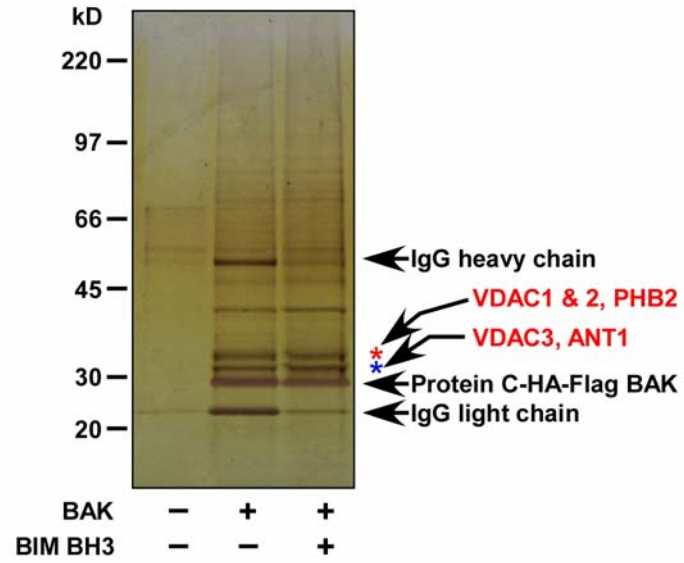

**B**

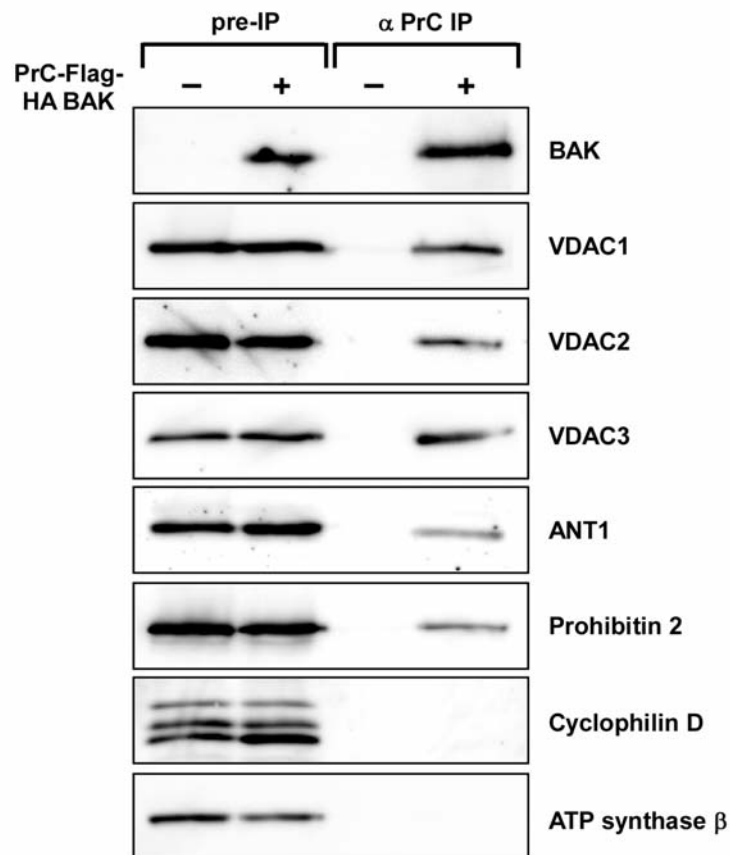

Figure 4.2

**A**

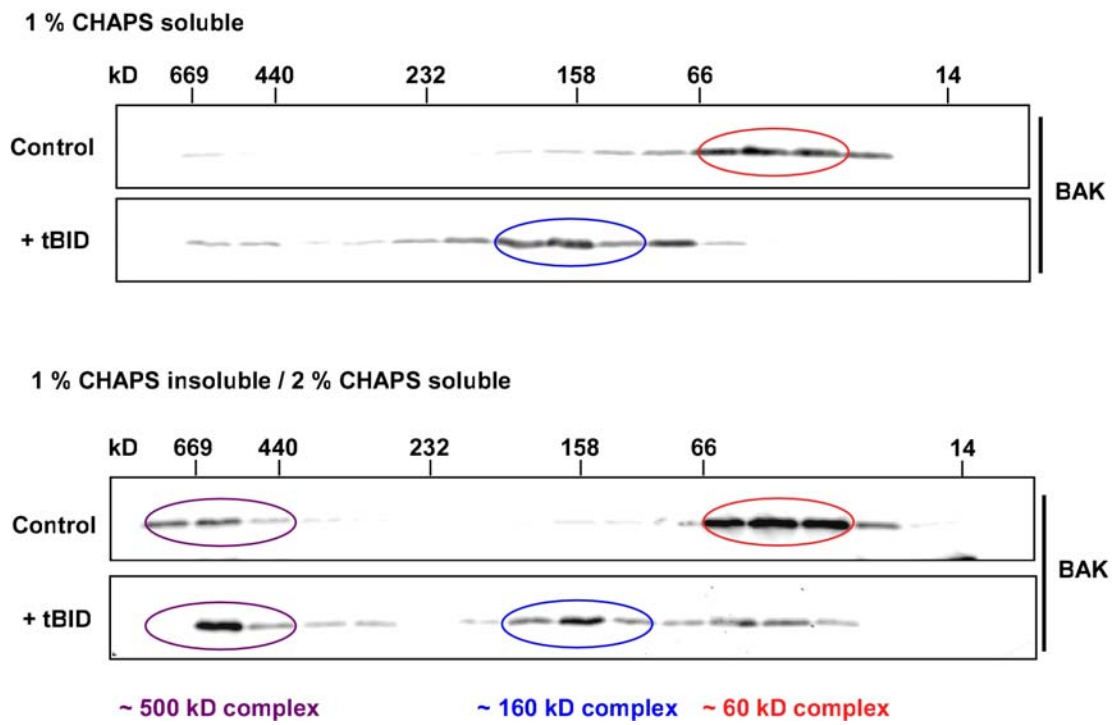

Figure 4.2

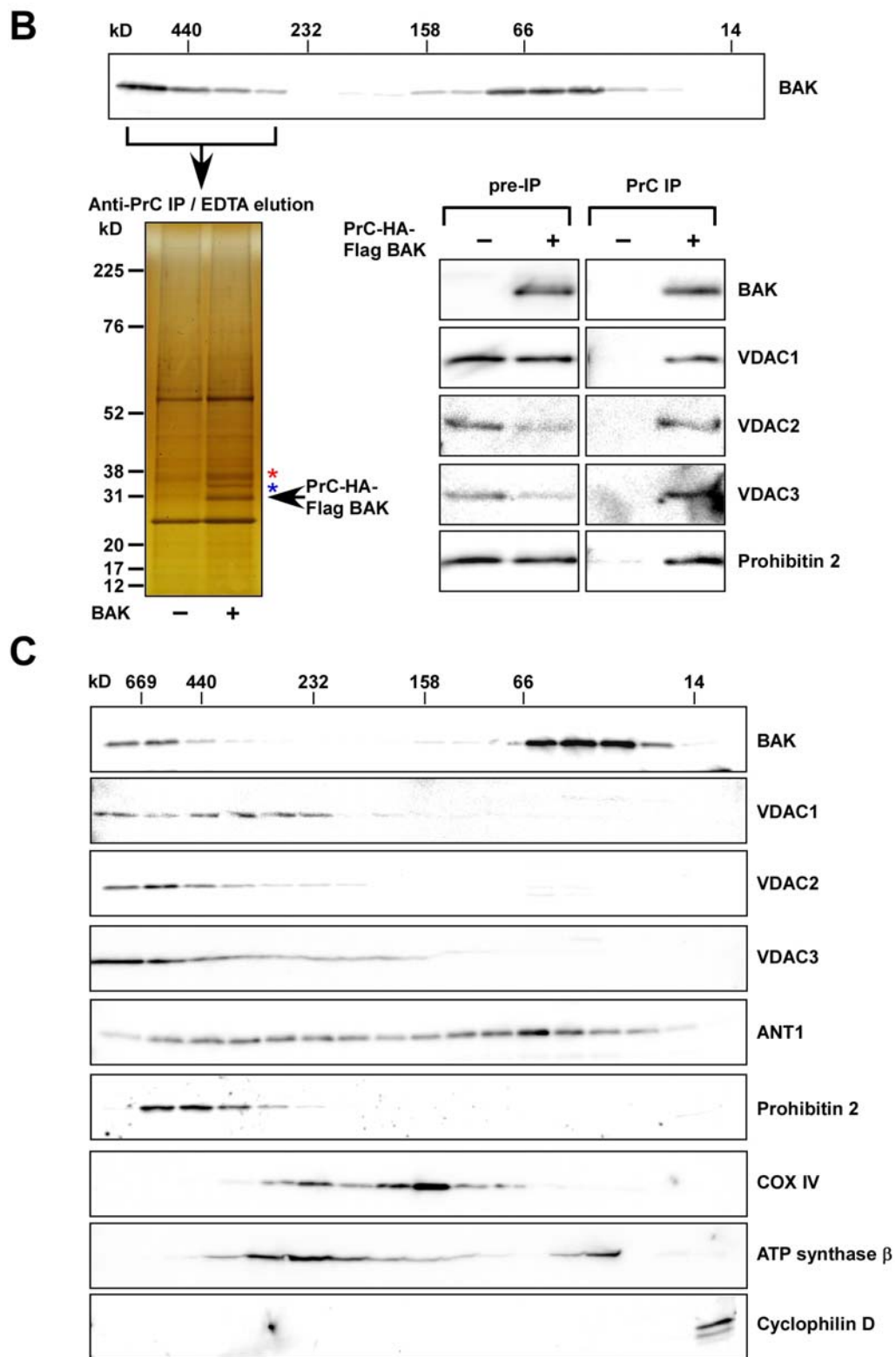
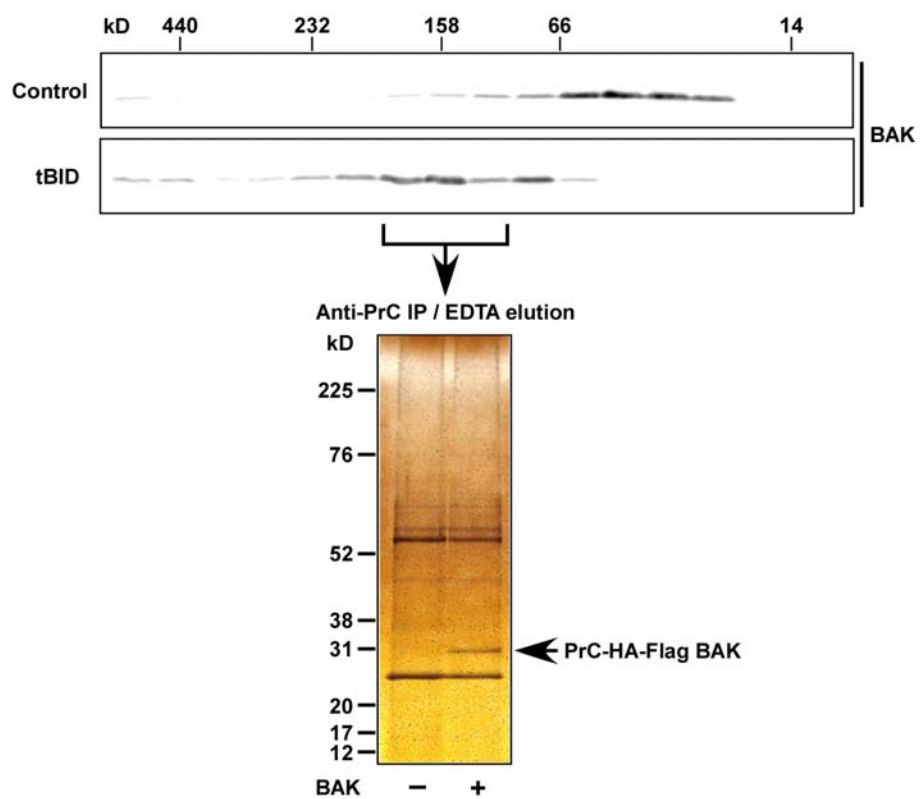
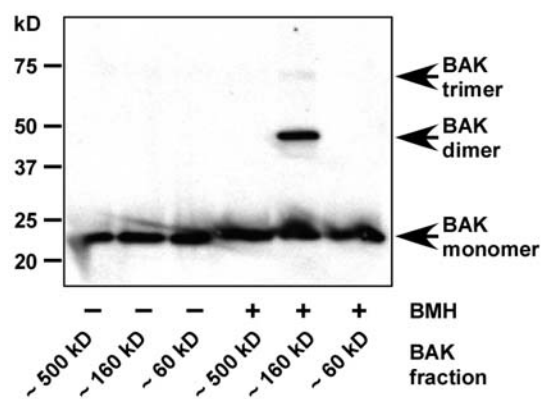

Figure 4.2

D



E



F

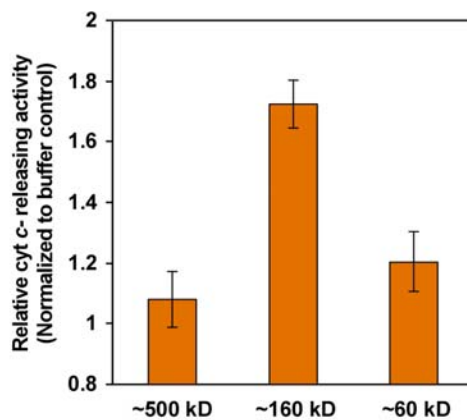

Figure 4.2

**G**

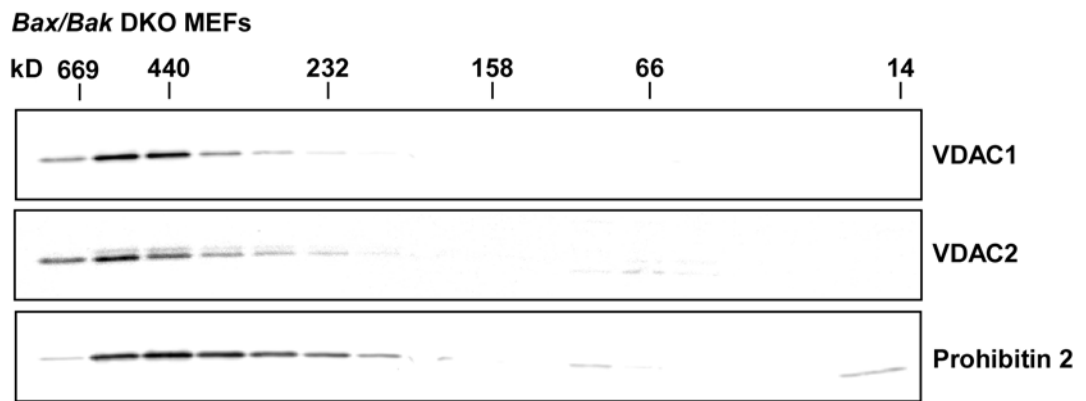
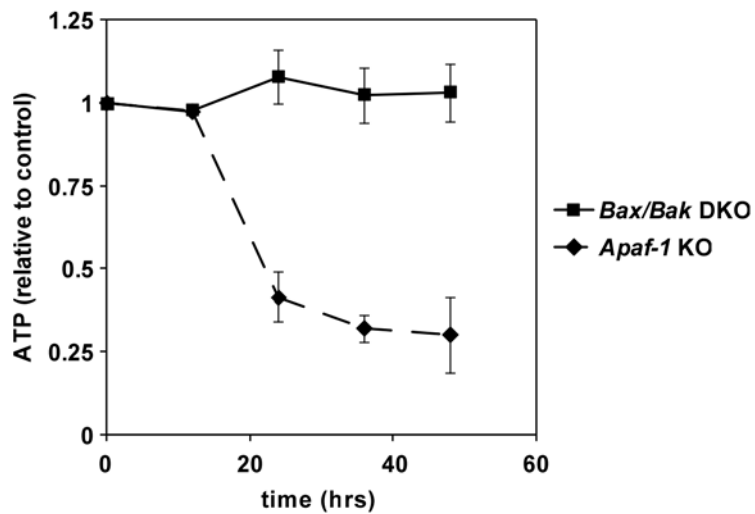
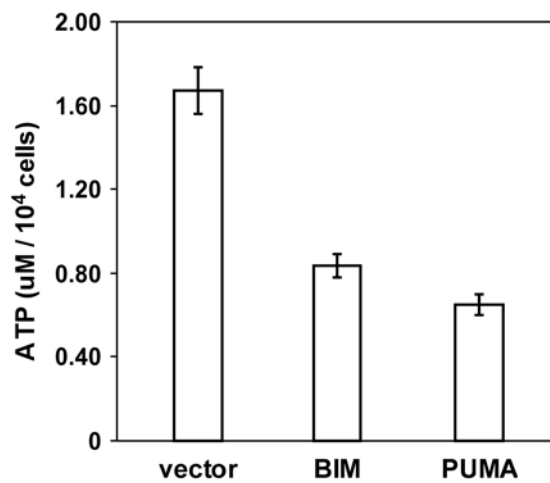

Figure 4.3

**A**



**B**



**C**

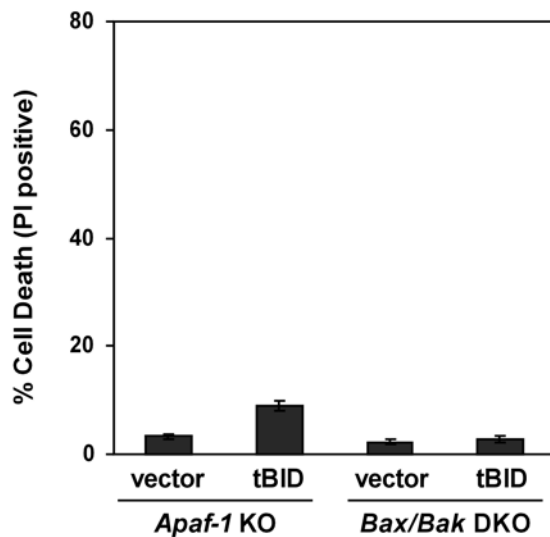
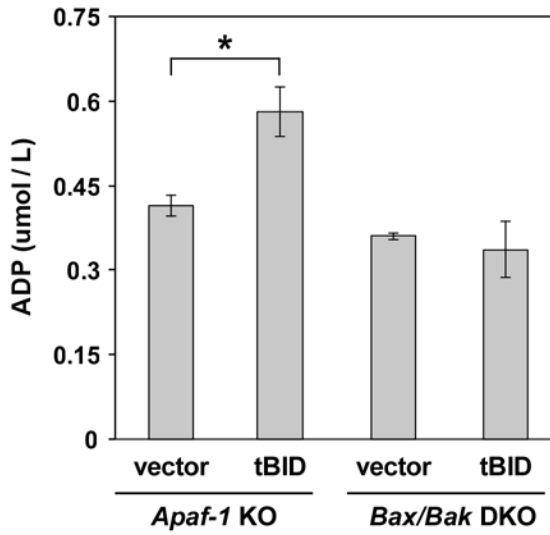
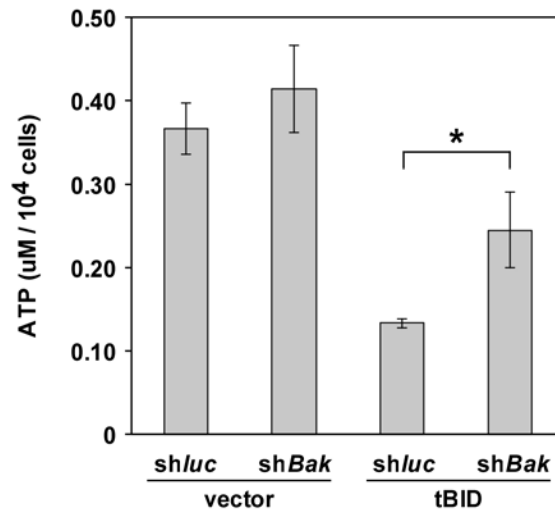

Figure 4.3

D



E



F

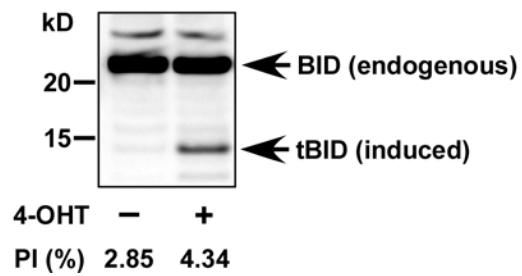
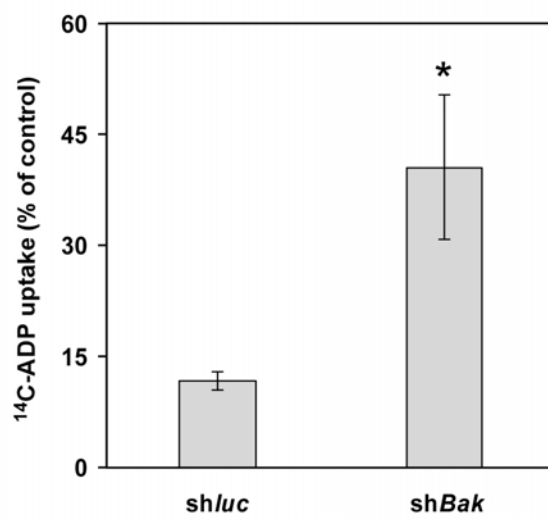

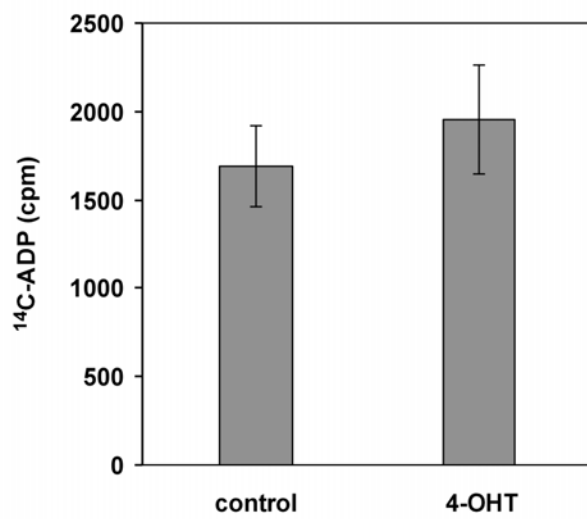

Figure 4.3

**G**



**H**



**I**

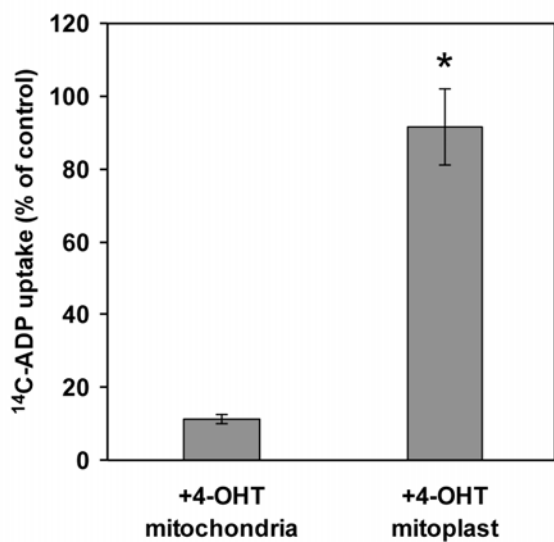
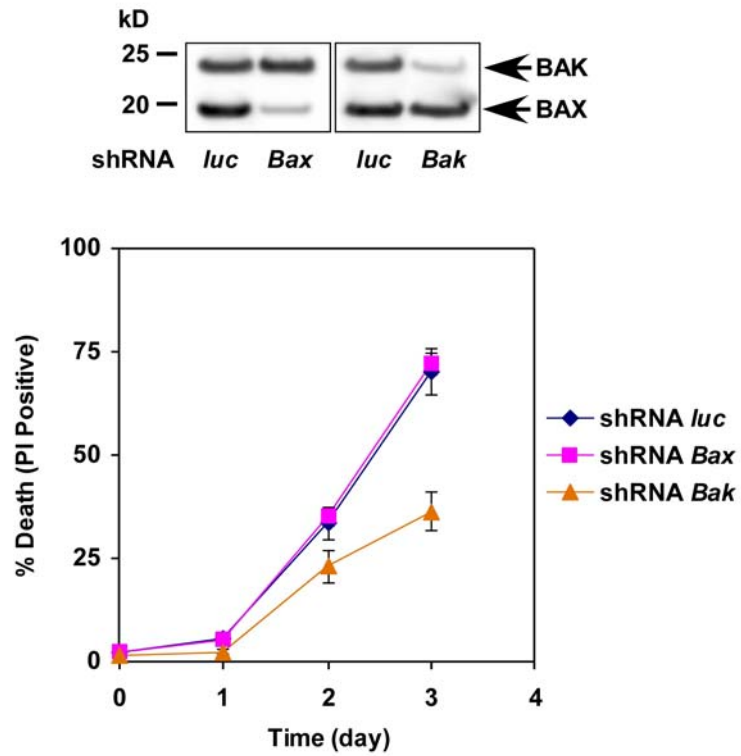

Figure 4.4

**A**



**B**

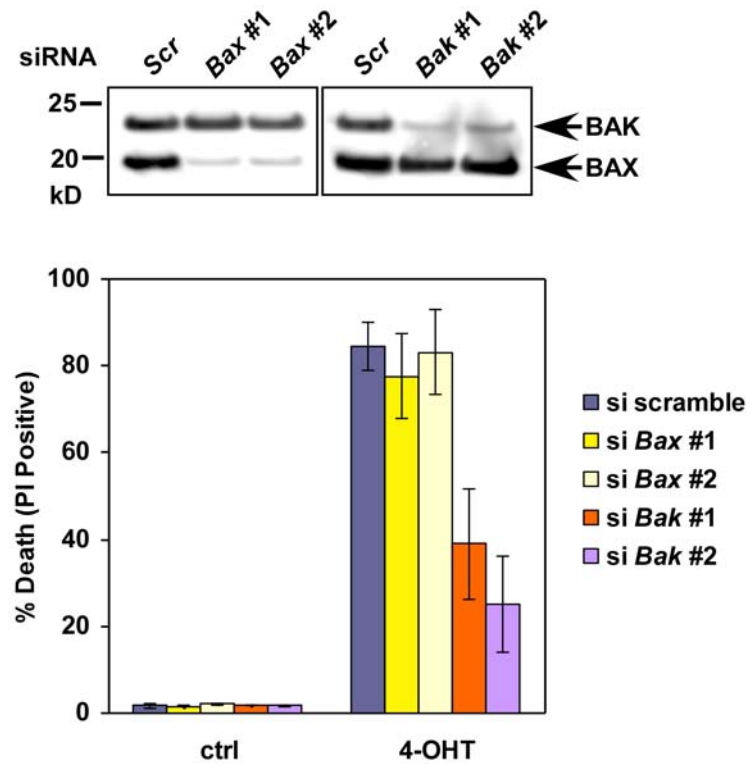

Figure 4.4

C

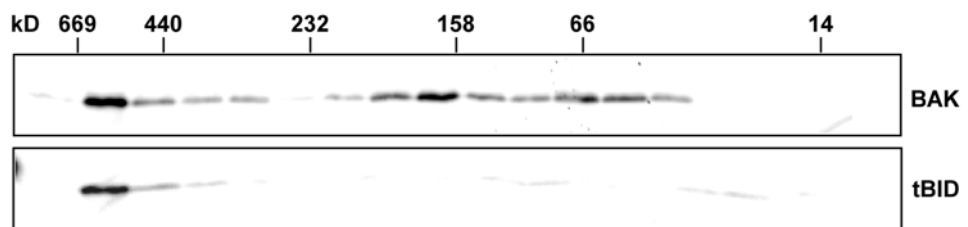
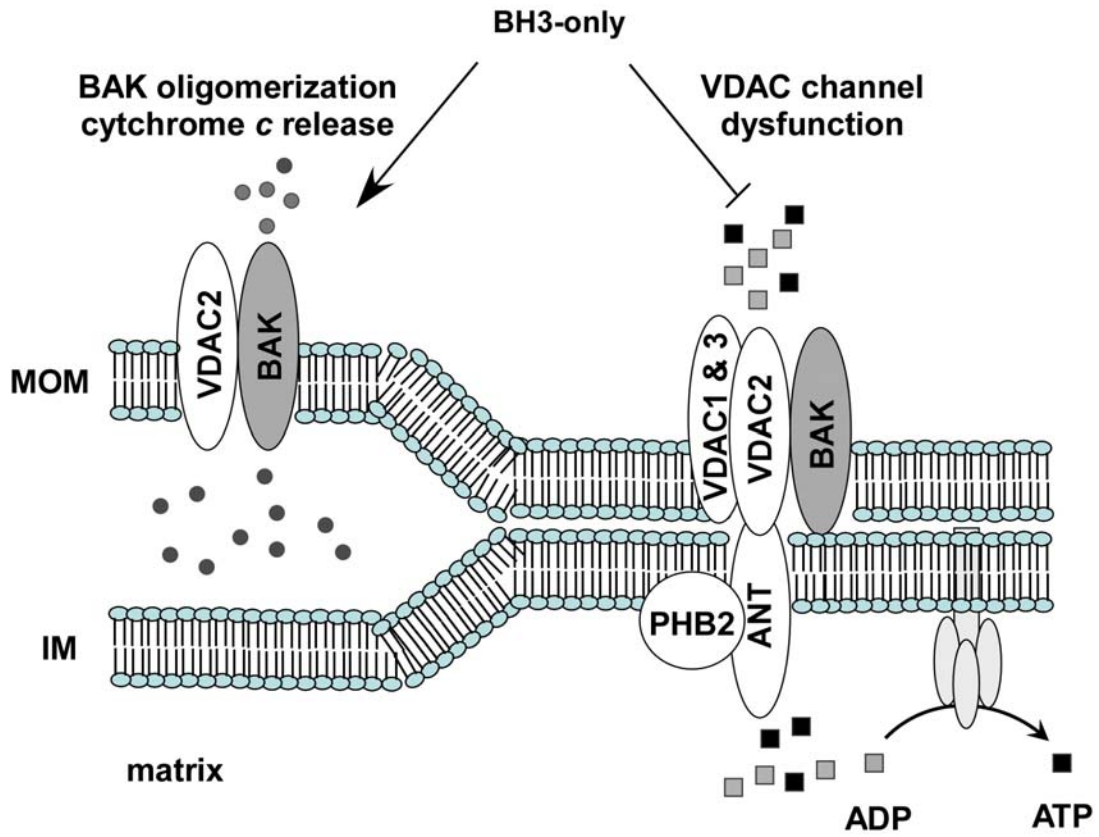

Figure 4.5



**- CHAPTER 5 -**

**Conclusion and Future Directions**

## 5.1. Conclusion

The studies described in this dissertation investigate the dynamics between the three BCL-2 subfamilies, and how these interactions affect the death effector function of BAX/BAK to determine the decision of cell survival versus death in the mitochondrial cell death program. From the work in chapter 2, I determined the relative contribution of each anti-death and prodeath BCL-2 subfamily member in regulating mitochondrial apoptosis. Unlike the simple ‘two-class’ model, this study established a hierarchical regulation of BCL-2 family members in BH3-mediated BAX/BAK activation. In response to death stimuli, ‘inactivator’ BH3s bind and inactivate anti-apoptotic BCL-2 members with unique specificity, liberating sequestered ‘activator’ BH3s so that they can directly induce BAX/BAK activation. In this proapoptotic BCL-2 signaling cascade, cell death triggered by inactivator BH3s obviously requires downstream activator BH3s. This is in contrast with the ‘indirect’ model that explains the discrete pro-death potency of BH3s by their relative binding affinity to anti-apoptotic BCL-2 members. Importantly, by employing full-length BH3-only proteins produced by an *in vitro* transcription/translation system, the ambiguous role of BIM and PUMA has been resolved. Similarly to tBID, they are *bona fide* activator BH3s that can directly activate BAX/BAK. Another important contribution of this study to the apoptosis field is the identification of instructive point mutants of BAX/BAK and tBID, which proved that BAX/BAK activation is directly triggered by activator BH3s rather than by the disengagement of BAX/BAK from anti-apoptotic BCL-2 members. Moreover, anti-apoptotic BCL-2 proteins principally prevent apoptosis through inhibiting BH3s rather than BAX/BAK.

The work in chapter 3 was focused on dissecting the molecular mechanism by which BAX/BAK is activated by activator BH3s. It revealed that BAX undergoes continuous structural reorganization to proceed to mitochondrial translocation and homo-oligomerization, both of which are directly triggered by activator BH3s. Mechanistically, activator BH3s initiate BAX activation by transiently interacting with the  $\alpha 1$  helix of BAX to induce the conformational change of BAX, leading to the disengagement of its  $\alpha 9$  transmembrane domain and the release of auto-inhibitory state. Activator BH3s stay associated with N- and C-termini-exposed BAX through the BH1 domain within the canonical dimerization pocket, inducing BAX homo-oligomerization at the mitochondria. Of note, stable interaction between BAX and BH3s could be captured in solution using the conformation-specific anti-BAX antibody. By reconstituting each BAX/BAK mutant into the *Bax/Bak* double-deficient background, I was also able to demonstrate that not only the BH3, but also the BH1 domain is required for BAX/BAK activation, emphasizing the role of BAX/BAK as a death receptor that can accommodate the death ligand BH3s. In addition, the selective targeting of BAK to the ER or the mitochondria demonstrated that BAK needs to be localized to the mitochondria to execute apoptosis triggered by intrinsic death signals. Furthermore, BH3s act as a liaison to relay upstream signals to BAX/BAK at the mitochondria as shown by impeded BAX/BAK oligomerization in *Bim/Puma* double knockout cells upon ER stress.

Lastly, chapter 4 explored the mechanism of BAK-mediated caspase-independent mitochondrial dysfunction. This study was initiated by the observation that upon expression of BH3s, *Apaf-1*-deficient cells exhibit loss of mitochondrial membrane potential and slowly proceed to cell death, while *Bax/Bak* DKO cells retain mitochondrial

membrane potential and are completely resistant to death. Affinity purification and gel filtration analyses allowed me to identify a higher-ordered BAK complex that contains the VDAC/ANT channels, which is functionally different from the cytochrome *c*-releasing BAK oligomers. Upon activation by BH3s, BAK promotes cell death by triggering VDAC dysfunction, leading to a defect in ADP transport and the subsequent loss of ATP production. Given that the VDAC2 isoform is a specific inhibitor of BAK-dependent apoptosis by its direct association with BAK, this study also implies that BAK and VDAC2 may have co-evolved to reciprocally regulate each other's function, allowing for crosstalk between apoptosis and mitochondrial physiology.

In conclusion, this thesis provides mechanistic insights into how the death signaling cascade of BCL-2 family members regulates the BAX/BAK-dependent cell death program, and resolves some of the critical questions heretofore unanswered in the apoptosis field. The field has witnessed tremendous conceptual and technical breakthroughs over the past two decades in elucidating how the dynamic interactions between BCL-2 family proteins execute the mitochondrion-dependent cell death program. The work presented in this thesis will contribute to shaping the framework to meet the next challenge the future holds: better appreciation of the functional network of BCL-2 family members and translation the knowledge into the development of therapeutics for cancer treatment, some of which are discussed below.



## 5.2. Future directions

### *Genetic proof of the hierarchy model*

The hierarchy model established in chapter 2 suggests that tBID, BIM, and PUMA are more potent BH3s since they can directly engage BAX/BAK to trigger its activation. This model predicts that the absence of these activator BH3s should have an extensive impact on triggering apoptosis for embryonic development and tissue homeostasis. Indeed, knockout mouse models of this subgroup have proven that single knockout of either *Bid*, *Bim*, or *Puma* exhibits much stronger phenotypes than that of other BH3s (Bouillet et al., 1999; Jeffers et al., 2003; Yin et al., 1999). This is especially true for the loss of BIM, which causes an increase in blood leukocytes, an abnormal CD4/CD8 ratio during T-cell development, defects in negative selection of thymocytes, and a resistance of lymphocytes to cytokine deprivation, calcium ion flux, and microtubule perturbation (Bouillet et al., 1999; Bouillet et al., 2002). Of note, deletion of both *Bim* and *Puma* has revealed new defects that were not apparent in the single knockout such as exacerbation of hematopoietic defects, hyperplasia of lymphatic organs, and spontaneous tumorigenesis (Erlacher et al., 2006). In contrast, combined loss of *Bid* and *Bim* does not confer any additional phenotypes, suggesting that functional redundancy exists among activator BH3s (Willis et al., 2007). Therefore, these results suggest that the generation of a *Bid/Bim/Puma* triple knockout should be pursued in order to reveal any compound phenotype masked by functional complementation. This mouse will also be a valuable tool for addressing the question of whether the deletion of all known activator BH3s can phenocopy the defects seen in *Bax/Bak* DKO animals.

Ultimately, the genetic proof of the importance of BID, BIM, and PUMA in triggering apoptosis during development and in response to cellular damage would strongly support the direct BAX/BAK activation model *in vivo*.

### ***Therapeutic implications***

The hierarchy model of BAX/BAK activation suggests that a small molecule that can occupy the binding pocket of anti-apoptotic BCL-2 members can be utilized to trigger apoptosis by mimicking the function of inactivator BH3s; such a compound can displace activator BH3s from anti-apoptotic BCL-2 members to activate BAX/BAK. Previously, ABT-737 was developed by NMR-based compound screening as an antagonist of the anti-apoptotic BCL-2 members to trigger apoptosis in cancer (Oltersdorf et al., 2005). ABT-737 is a BH3 mimetic of the inactivator BH3-only BAD that can bind and inhibit BCL-2, BCL-X<sub>L</sub>, and BCL-W. This compound, which is currently in Phase I and II clinical trials as an orally available form ABT-263, exhibits synergistic effects with chemotherapeutics in several tumor cell lines as well as single-agent efficacy in cell lines from lymphoid malignancies and small-cell lung cancer (Oltersdorf et al., 2005). ABT-737 was mechanistically shown to displace BIM from BCL-2 to activate BAX and induce cell death in chronic lymphocytic leukemia (Del Gaizo Moore et al., 2007). This demonstrates that inactivator BH3 mimetics can be used to selectively kill cancer cells by exploiting the dependence of cancer cells on BCL-2 overexpression to sequester the elevated activator BH3s. On the other hand, resistance to ABT-737 was attributed to the overexpression of anti-apoptotic MCL-1, which cannot be targeted by the BAD BH3 mimetic ABT-737 due to its distinct binding cleft (Konopleva et al., 2006; Lin et al.,

2006; Van Delft et al., 2006). Cyclin-dependent kinase inhibitor or protein synthesis inhibitor has been used to reduce MCL-1 level that has relatively short half-life therefore sensitize cells refractory to ABT-737 (Chen et al., 2007; Lin et al., 2006; Van Delft et al., 2006). However, since the strategy may have global impacts on transcription and translation with unknown side-effects, designing a more tailored BH3 mimetics is required to selectively target MCL-1 as anti-cancer drug. Although another BH3 mimetic TW-37 shows pleiotropic effects not only on BCL-2 and BCL-X<sub>L</sub>, but also on MCL-1, the sole specificity to MCL-1 has not been achieved yet (Wang et al., 2006).

The functional network of BCL-2 family members described in chapter 2 can be useful information in developing BH3 mimetics that will selectively induce apoptosis in cancer cells. It was demonstrated in chapter 2 that anti-apoptotic BCL-2 members are not functionally equivalent, and accordingly, they are differentially inactivated by inactivator BH3s depending on the different affinity and selectivity of the association among BH3s and anti-apoptotic BCL-2 members. By obtaining expression profile of both activator BH3s and anti-apoptotic BCL-2 members, the dependence of cancer cells on specific anti-apoptotic BCL-2 members can be determined prior to a targeted therapy. In addition, a more rational therapeutic approach would be possible using a fine-tuned BH3 mimetic that represents the unique range of a specific inactivator BH3. Furthermore, assessing the expression pattern of both anti-apoptotic BCL-2 members and activator BH3s would help determine what types of tumors are more susceptible to therapeutics.

### ***BAX-containing cytochrome c-releasing machinery***

Although the ability of the liposome system to faithfully recapitulate the BAX-mediated membrane permeabilization *in vitro* argues that activated BAX is sufficient to form pores to release cytochrome *c* (Saito et al., 2000; Kuwana et al., 2002; Walensky et al., 2006), the composition of the BAX-containing pore formed in the mitochondrial outer membrane during apoptosis remains uncharacterized. It is possible that a mitochondrial or a cytosolic protein that is not an essential component of the cytochrome *c*-releasing machinery may facilitate the BAX-containing pore-forming process. For instance, TOM22, a mitochondrial outer membrane translocator, was shown to be important for the insertion of BAX into the mitochondrial membrane (Bellot et al., 2007). However, whether this protein is also involved in the oligomerization process is unknown. Biochemical purification of mitochondria-inserted BAX oligomers from isolated mitochondria after treatment of activator BH3s or death stimuli may help identify new components of the pore complex or proteins that assist in pore formation.

In addition, the question of whether lipids from the mitochondrial outer membrane directly participate in BAX-pore formation is an attractive topic of future research. The recently proposed “embedded together” model attempts to integrate both direct and indirect BAX/BAK activation models by incorporating the membrane as a critical component in regulating the dynamics of BCL-2 family members at the mitochondria (Leber et al., 2007). Moreover, the levels of cardiolipin and cholesterol present in the mitochondrial outer membrane have been implicated in regulating BAX insertion and oligomerization (Lucken-Ardjomande et al., 2008a, b). Also, tBID can interact with cardiolipin to produce a structural distortion in the lipid bilayer that contributes to BAX-mediated membrane permeabilization, suggesting that the lipid

content in the mitochondrial outer membrane may be a limiting factor for BAX-containing pore formation *in vivo* (Terrones et al., 2004).

The nature of the BAX-containing pore also remains obscure. On the one hand, it was suggested that tBID and BAX synergistically form supramolecular openings that are lipidic in nature (Kuwana et al., 2002; Terrones et al., 2004). Cryoelectron microscopy of proteo-liposomes acquired from mitochondrial outer membrane revealed that tBID and BAX form large pore-like lipidic openings with a diameter of 25-100 nm (Schafer et al., 2009). On the other hand, a mitochondrial apoptosis-induced channel (MAC) was initially reported to form in the presence of BAX and/or BAK and correlate with cytochrome *c* release and initiation of apoptosis (Pavlov et al., 2001). It was recently demonstrated that this channel is a circular pore with a diameter of 5.5-6 nm, formed by successive insertion of BAX  $\alpha$ 5 and  $\alpha$ 6 helices, which ultimately contains 9-10 BAX monomers (Martinez-Caballero et al., 2009). The stepwise increase in permeability and conductance shown by the patch clamp analysis of MAC argues against the lipidic nature of the BAX pores (Martinez-Caballero et al., 2009). In this sense, it is crucial to develop a technique that can visualize the formation of BAX-containing pores in real-time, especially at a single-molecule level with isolated mitochondria, so that one can follow the process of how BAX grows to dimer, tetramer, and higher-ordered oligomers.

### ***The BAX/BAK oligomerization process***

The work of chapter 3 demonstrated that activator BH3s induce the oligomerization of the mitochondria-inserted BAX/BAK monomers, with both BH1 and BH3 domains required to form BAX/BAK homo-dimers. However, the subsequent

conformational changes and domains required for the assembly into higher-ordered oligomers remain a mystery. BAK activation was shown to involve the formation of symmetrical dimers through reciprocal binding between the exposed BH3 domain and the hydrophobic pocket, implying that the opposing interface, including  $\alpha 4$  and/or  $\alpha 6$  helix, may be important for the assembly of higher-ordered oligomers (Dewson et al., 2008). Intriguingly, X-ray crystallography of N/C-terminus-deleted BAK revealed that BAK can constitute a  $Zn^{2+}$ -dependent symmetrical dimer, whose interface includes  $Zn^{2+}$  binding residues of Asp<sup>160</sup> and His<sup>164</sup> at the  $\alpha 6$  helix and the opposite end of the  $\alpha 4$  helix, which does not involve any BH1-3 domain (Moldoveanu et al., 2006). This indicates that besides the canonical dimerization pocket, the opposing interface can mediate BAK-BAK interactions. In contrast, it was suggested that the central  $\alpha 5$  and  $\alpha 6$  helices of BAX are potential pore-forming domains that are inserted into the mitochondrial outer membrane, constituting a multi-spanning BAX monomer (Annis et al., 2005; Nouraini et al., 2000). In this scenario, membrane insertion of the central helices would disassemble the BH3-binding hydrophobic pocket, indicating that an alternative mechanism should exist to form dimers. Substantial interaction of a multi-spanning BAX monomer with mitochondrial lipids may assist the assembly of BAX molecules. However, detailed information on the orientation of the central helices or the degree of penetration into the membrane is lacking, and the requirement of this configuration for proceeding to oligomerization is currently unknown. Therefore, identification of BAX/BAK point mutants that are not able to insert efficiently into the membrane or proceed to oligomerization from dimerization will increase our understanding of the molecular mechanisms by which BAX/BAK oligomers are formed at the mitochondria.

### ***Hit-and-run mechanism of BAX/BAK activation***

The work of chapter 3 emphasizes the transient ‘hit-and-run’ mechanism in activator BH3-induced BAX/BAK activation. The BH3-BAX/BAK interaction must be transient in nature to allow BAX/BAK to homo-oligomerize since both homo-dimerization and hetero-dimerization involve the same hydrophobic pocket. Recently, the ordered series of tBID-induced BAX oligomerization and membrane permeabilization was monitored by a FRET-based liposome-reconstitution experiment (Lovell et al., 2008). Also, real-time single cell analysis by FRET made it possible to examine the spatiotemporal change of BAX subcellular localization induced by PUMA (Zhang et al., 2009). These two studies open a new avenue for visualizing the dynamic interactions among BCL-2 family proteins in controlling BAX/BAK activation via such a ‘hit-and-run’ mechanism. By using BAX BH1 or BH3 domain mutants that cannot be activated by activator BH3s, the real-time FRET between BH3s and BAX can be monitored upon expression of different activator BH3s and compared with the translocation kinetics of wild-type BAX. Also, the mutagenesis at the novel BIM interaction site within the BAX  $\alpha 1$  and  $\alpha 6$  helices identified by Gavathiotis et al., when combined with FRET, will help reveal the detailed binding interfaces of BH3s to BAX for BAX conformational change. Furthermore, the FRET-based liposome experiment will allow us to explore the differential binding specificities among different BCL-2 subfamily binding partners and their effect on membrane permeabilization by measuring the FRET of specific partner molecules in the presence of membranes.

### ***VDAC, cell death, and cancer***

The work of chapter 4 suggests that decreased ATP production from oxidative phosphorylation due to a defect of ATP/ADP transport is an important determinant in triggering BH3s-induced BAK-dependent mitochondrial dysfunction. Another source of ATP production inside the cell is the substrate-level phosphorylation from the glycolytic pathway, which generates two net molecules of ATP per glucose. Hexokinase (HK) is responsible for the first step of glycolysis by catalyzing the ATP-dependent phosphorylation of glucose. Interestingly, HK-I and -II isoforms are bound to the mitochondrial outer membrane through the interactions with VDAC, which gives HK preferential access to mitochondrial ATP generated from the respiratory chain by positioning it at the point of mitochondrial ATP export (Robey and Hay, 2006). The coupling of intra-mitochondrial oxidative phosphorylation and extra-mitochondrial glycolysis has been implicated in cancer cells that exhibit a high rate of glycolysis even in the presence of oxygen (Jones and Thompson, 2009). One of the molecular bases for this phenomenon is the overexpression of the VDAC-associated HK at the mitochondria of cancer cells to increase the rate of ATP production (Pedersen, 2007). In addition, AKT-mediated promotion of HK activity and an increase in its association with mitochondria are implicated in protecting cells from growth factor-withdrawal induced cell death (Gottlob et al., 2001; Rathmell et al., 2003). This proposed mechanism may also provide significant advantage for cancer cells to survive. Accordingly, it was recently reported that a plant stress, hormone methyl jasmonate, affects the mitochondrial function of cancer cells by disrupting VDAC-HK association and triggers cell death, suggesting that uncoupling intra- and extra-mitochondrial metabolism can be an useful approach for anti-cancer therapy (Goldin et al., 2008). In this sense, it is possible that the



cell death signals converging on mitochondria promote cell death not only by inducing mitochondrial membrane permeabilization, but also by actively shutting down glycolysis through interfering with the VDAC-HK interaction. Therefore, it will be interesting to determine whether BH3s are recruited to the higher-ordered BAK complex not only to trigger BAK-dependent VDAC channel dysfunction but also to dissociate HK from the complex, which can further contribute to the cellular demise induced by mitochondrial dysfunction.

Finally, VDACS are found to be highly expressed in cancer cells when compared to normal cells (Simamura et al., 2006; Yagoda et al., 2007). Given that in cancer cells, a high rate of glycolysis may require the upregulation of VDAC-mediated ATP/ADP transport, VDACS may be novel pharmacological targets for anti-cancer therapy. For instance, furanonaphthoquinones (FNQs) induce caspase-dependent apoptosis by the production of ROS via VDAC1 (Simamura et al., 2003; Simamura et al., 2006). Erastin triggers RAS-RAF-MEK-dependent oxidative cell death by acting through a direct association with VDAC2, indicating that the VDAC ligand can serve to selectively target cancer cells (Yagoda et al., 2007).

### ***Concluding remarks***

Here, I have explored the underlying mechanism of how the BAX/BAK-dependent cell death program operates and demonstrated that tightly controlled intermolecular interactions and conformational changes of BCL-2 family members dictate the response to various apoptotic stimuli. Integration of apoptotic signaling with mitochondrial physiology, which converges on BAK at the mitochondria, also ensures

the execution of cell death with high fidelity. Although understanding the details of basic biology of BCL-2 family members in regulating mitochondrion-dependent cell death is far from complete, this work along with others will advance our knowledge of how cells are programmed to die and set the stage for developing rational therapeutics to target cancer, where programmed cell death pathways are often derailed.

## References

- Adams, J.M., and Cory, S. (2007). The Bcl-2 apoptotic switch in cancer development and therapy. *Oncogene* 26, 1324-1337.
- Annis, M.G., Soucie, E. L., Dlugosz, P. J., Crux-Aguado, J. A., Penn, L. Z., Leber, B., Andrews, D. W. (2005). Bax forms multispinning monomers that oligomerize to permeabilize membranes during apoptosis. *EMBO J* 24, 2096-2103.
- Antonsson, B., Montessuit, S., Sanchez, B., and Martinou, J.C. (2001). Bax is present as a high molecular weight oligomer/complex in the mitochondrial membrane of apoptotic cells. *J Biol Chem* 276, 11615-11623.
- Baines, C.P., Kaiser, R.A., Purcell, N.H., Blair, N.S., Osinska, H., Hambleton, M.A., Brunskill, E.W., Sayen, M.R., Gottlieb, R.A., Dorn, G.W., *et al.* (2005). Loss of cyclophilin D reveals a critical role for mitochondrial permeability transition in cell death. *Nature* 434, 658-662.
- Bakhshi, A., Jensen, J.P., Goldman, P., Wright, J.J., McBride, O.W., Epstein, A.L., and Korsmeyer, S.J. (1985). Cloning the chromosomal breakpoint of t(14;18) human lymphomas: clustering around JH on chromosome 14 and near a transcriptional unit on 18. *Cell* 41, 899-906.
- Bayrhuber, M., Meins, T., Habeck, M., Becker, S., Giller, K., Villinger, S., Vonrhein, C., Griesinger, C., Zweckstetter, M., and Zeth, K. (2008). Structure of the human voltage-dependent anion channel. *Proc Natl Acad Sci USA* 105, 15370-15375.
- Bellot, G., Cartron, P.F., Er, E., Oliver, L., Juin, P., Armstrong, L.C., Bornstein, P., Mihara, K., Manon, S., and Vallette, F.M. (2007). TOM22, a core component of the mitochondria outer membrane protein translocation pore, is a mitochondrial receptor for the proapoptotic protein Bax. *Cell Death Differ* 14, 785-794.
- Beutner, G., Rück, A., Riede, B., Welte, W., and Brdiczka, D. (1996). Complexes between kinases, mitochondrial porin and adenylate translocator in rat brain resemble the permeability transition pore. *FEBS Letters* 396, 189-195.
- Bouillet, P., Metcalf, D., Huang, D.C., Tarlinton, D.M., Kay, T.W., H., Kongten, F., *et al.* (1999). Proapoptotic Bcl-2 relative Bim required for certain apoptotic responses, leukocyte homeostasis, and to preclude autoimmunity. *Science* 286, 1735-1738.
- Bouillet, P., Cory, S., Zhang, L.C., Strasser, A., and Adams, J.M. (2001). Degenerative disorders caused by Bcl-2 deficiency prevented by loss of its BH3-only antagonist Bim. *Dev Cell* 1, 645-653.

- Bouillet, P., Purton, J.F., Godfrey, D.I., Zhang, L.-C., Coultas, L., Puthalakath, H., Pellegrini, M., Cory, S., Adams, J.M., and Strasser, A. (2002). BH3-only Bcl-2 family member Bim is required for apoptosis of autoreactive thymocytes. *Nature* *415*, 922-926.
- Brdiczka, D.G., Zorov, D.B., and Sheu, S.-S. (2006). Mitochondrial contact sites: Their role in energy metabolism and apoptosis. *Biochim Biophys Acta* *1762*, 148-163.
- Brdiczka, C.G. (2007) Energy transfer network, metabolic feedback regulation, and modeling of cellular energetics. *Molecular System Bioenergetics: Energy for Life: Part II*. 165-194
- Cartron, P.-F., Priault, M., Oliver, L., Meflah, K., Manon, S., and Vallette, F.M. (2003). The N-terminal end of Bax contains a mitochondrial-targeting signal. *J Biol Chem* *278*, 11633-11641.
- Cartron, P.-F., Gallenne, T., Bougras, G., Gautier, F., Manero, F., Vusio, P., Meflah, K., Vallette, F.M., and Juin, P. (2004). The first alpha Helix of Bax plays a necessary role in its ligand-induced activation by the BH3-only proteins Bid and PUMA. *Mol Cell* *16*, 807-818.
- Chen, L., Willis, S.N., Wei, A., Smith, B.J., Fletcher, J.I., Hinds, M.G., Colman, P.M., Day, C.L., Adams, J.M., and Huang, D.C.S. (2005). Differential targeting of prosurvival Bcl-2 proteins by their BH3-only ligands allows complementary apoptotic function. *Mol Cell* *17*, 393-403.
- Chen, R., Valencia, I., Zhong, F., McColl, K.S., Roderick, H.L., Bootman, M.D., Berridge, M.J., Conway, S.J., Holmes, A.B., Mignery, G.A., *et al.* (2004). Bcl-2 functionally interacts with inositol 1,4,5-trisphosphate receptors to regulate calcium release from the ER in response to inositol 1,4,5-trisphosphate. *J Cell Biol* *166*, 193-203.
- Chen, S., Dai, Y., Harada, H., Dent, P., and Grant, S. (2007). Mcl-1 down-regulation potentiates ABT-737 lethality by cooperatively inducing Bak activation and Bax translocation. *Cancer Res* *67*, 782-791.
- Cheng, E.H., Wei, M.C., Weiler, S., Flavell, R.A., Mak, T.W., Lindsten, T., and Korsmeyer, S.J. (2001). BCL-2, BCL-X<sub>L</sub> sequester BH3 domain-only molecules preventing BAX- and BAK-mediated mitochondrial apoptosis. *Mol Cell* *8*, 705-711.
- Cheng, E.H., Sheiko, T.V., Fisher, J.K., Craigen, W.J., and Korsmeyer, S.J. (2003). VDAC2 inhibits BAK activation and mitochondrial apoptosis. *Science* *301*, 513-517.
- Chipuk, J.E., Bouchier-Hayes, L., Kuwana, T., Newmeyer, D.D., and Green, D.R. (2005). PUMA couples the nuclear and cytoplasmic proapoptotic function of p53. *Science* *309*, 1732-1735.

- Chipuk, J.E., and Green, D.R. (2008). How do BCL-2 proteins induce mitochondrial outer membrane permeabilization? *Trends Cell Biol* *18*, 157-164.
- Chittenden, T., Flemington, C., Houghton, A. B., Ebb, R. G., Gallo, G. J., Elangovan, B., Chinnadurai, G., and Lutz, R. J. (1995). A conserved domain in Bak, distinct from BH1 and BH2, mediates cell death and protein binding functions. *EMBO J* *14*, 5589–5596
- Chou, J.J., Li, H., Salvesen, G.S., Yuan, J., and Wagner, G. (1999). Solution structure of BID, an intracellular amplifier of apoptotic signaling. *Cell* *96*, 615-624.
- Cleary, M.L., Smith, S.D., and Sklar, J. (1986). Cloning and structural analysis of cDNAs for bcl-2 and a hybrid bcl-2/immunoglobulin transcript resulting from the t(14;18) translocation. *Cell* *47*, 19-28.
- Colombini, M., Blachly-Dyson, E., and Forte, M. (1996). VDAC, a channel in the outer mitochondrial membrane. *Ion Channels*. *4*, 169–202.
- Cory, S., and Adams, J.M. (2002). The Bcl2 family: regulators of the cellular life-or-death switch. *Nature Rev Cancer* *2*, 647-656.
- Coultas, L., Bouillet, P., Stanley, E.G., Brodnicki, T.C., Adams, J.M., and Strasser, A. (2004). Proapoptotic BH3-only Bcl-2 family member Bik/Blk/Nbk is expressed in hemopoietic and endothelial cells but is redundant for their programmed death. *Mol Cell Biol* *24*, 1570-1581.
- Crompton, M., Barksby, E., Johnson, N., and Capano, M. (2002). Mitochondrial intermembrane junctional complexes and their involvement in cell death. *Biochimie* *84*, 143-152.
- Cuconati, A., Mukherjee, C., Perez, D., and White, E. (2003). DNA damage response and MCL-1 destruction initiate apoptosis in adenovirus-infected cells. *Genes Dev* *17*, 2922-2932.
- Danial, N.N., and Korsmeyer, S.J. (2004). Cell death: critical control points. *Cell* *116*, 205-219.
- Degterev, A., Boyce, M., and Yuan, J. (2003). A decade of caspases. *Oncogene* *22*, 8543-8567.
- Del Gaizo Moore, V., Brown, J.R., Certo, M., Love, T.M., Novina, C.D., and Letai, A. (2007). Chronic lymphocytic leukemia requires BCL2 to sequester prodeath BIM, explaining sensitivity to BCL2 antagonist ABT-737. *J Clin Invest* *117*, 112-121.
- Desagher, S., Osen-Sand, A., Nichols, A., Eskes, R., Montessuit, S., Lauper, S., Maundrell, K., Antonsson, B., and Martinou, J.-C. (1999). Bid-induced conformational

change of Bax is responsible for mitochondrial cytochrome *c* release during apoptosis. *J Cell Biol* *144*, 891-901.

Dewson, G., Kratina, T., Sim, H.W., Puthalakath, H., Adams, J.M., Colman, P.M., and Kluck, R.M. (2008). To trigger apoptosis, Bak exposes its BH3 domain and homodimerizes via BH3:Groove interactions. *Mol Cell* *30*, 369-380.

Dijkers, P.F., Medema, R.H., Lammers, J.W., Koenderman, L., and Coffey, P.J. (2000). Expression of the pro-apoptotic Bcl-2 family member Bim is regulated by the forkhead transcription factor FKHR-L1. *Curr Biol* *10*, 1201-1204.

Du, C., Fang, M., Li, Y., Li, L., and Wang, X. (2000). Smac, a mitochondrial protein that promotes cytochrome *c* dependent caspase activation by eliminating IAP inhibition. *Cell* *102*, 33-42.

Epand, R.F., Martinou, J.-C., Fornallaz-Mulhauser, M., Hughes, D.W., and Epand, R.M. (2002). The apoptotic protein tBid promotes leakage by altering membrane curvature. *J Biol Chem* *277*, 32632-32639.

Erlacher, M., Labi, V., Manzl, C., Bock, G., Tzankov, A., Hacker, G., Michalak, E., Strasser, A., and Villunger, A. (2006). Puma cooperates with Bim, the rate-limiting BH3-only protein in cell death during lymphocyte development, in apoptosis induction. *J Exp Med* *203*, 2939-2951.

Eskes, R., Desagher, S., Antonsson, B., and Martinou, J.-C. (2000). Bid induces the oligomerization and insertion of Bax into the outer mitochondrial membrane. *Mol Cell Biol* *20*, 929-935.

Fitch, M.E., Change, C.-M., and Parslow, T.G. (2000). The BH3 domain is required for caspase-independent cell death induced by Bax and oligomycin. *Cell Death Differ* *7*, 338-349.

Gavathiotis, E., Suzuki, M., Davis, M.L., Pitter, K., Bird, G.H., Katz, S.G., Tu, H.-C., Kim, H., Cheng, E.H.Y., Tjandra, N., *et al.* (2008). BAX activation is initiated at a novel interaction site. *Nature* *455*, 1076-1081.

George, N.M., Evans, J.J.D., and Luo, X. (2007). A three-helix homo-oligomerization domain containing BH3 and BH1 is responsible for the apoptotic activity of Bax. *Genes Dev* *21*, 1937-1948.

Goldin, N., Arzoine, L., Heyfets, A., Israelson, A., Zaslavsky, Z., Bravman, T., Bronner, V., Notcovich, A., Shoshan-Barmatz, V., and Flescher, E. (2008). Methyl jasmonate binds to and detaches mitochondria-bound hexokinase. *Oncogene* *27*, 4636-4643.

- Goping, I.S., Gross, A., Lavoie, J.N., Nguyen, M., Jemmerson, R., Roth, K., Korsmeyer, S.J., and Shore, G.C. (1998). Regulated targeting of BAX to mitochondria. *J Cell Biol* *143*, 207-215.
- Gottlob, K., Majewski, N., Kennedy, S., Kandel, E., Robey, R.B., and Hay, N. (2001). Inhibition of early apoptotic events by Akt/PKB is dependent on the first committed step of glycolysis and mitochondrial hexokinase. *Genes Dev* *15*, 1406-1418.
- Green, D.R., and Reed, J.C. (1998). Mitochondria and apoptosis. *Science* *281*, 1309-1312.
- Green, D.R., and Kroemer, G. (2004). The pathophysiology of mitochondrial cell death. *Science* *305*, 626-629.
- Griffiths, G.J., Dubrez, L., Morgan, C.P., Jones, N.A., Whitehouse, J., Corfe, B.M., Dive, C., and Hickman, J.A. (1999). Cell damage-induced conformational changes of the pro-apoptotic protein Bak *in vivo* precede the onset of apoptosis. *J Cell Biol* *144*, 903-914.
- Gross, A., Jockel, J., Wei, M.C., and Korsmeyer, S.J. (1998). Enforced dimerization of BAX results in its translocation, mitochondrial dysfunction and apoptosis. *EMBO J* *17*, 3878-3885.
- Gross, A., McDonnell, J.M., and Korsmeyer, S.J. (1999). BCL-2 family members and the mitochondria in apoptosis. *Genes Dev* *13*, 1899-1911.
- Gross, A., Pilcher, K., Blachly-Dyson, E., Basso, E., Jockel, J., Bassik, M.C., Korsmeyer, S.J., and Forte, M. (2000). Biochemical and genetic analysis of the mitochondrial response of yeast to BAX and BCL-X<sub>L</sub>. *Mol Cell Biol* *20*, 3125-3136.
- Guo, B., Zhai, D., Cabezas, E., Welsh, K., Nouraini, S., Satterthwait, A.C., and Reed, J.C. (2003). Humanin peptide suppresses apoptosis by interfering with Bax activation. *Nature* *423*, 456-461.
- Gustafsson, A.B., Tsai, J.G., Logue, S.E., Crow, M.T., and Gottlieb, R.A. (2004). Apoptosis repressor with caspase recruitment domain protects against cell death by interfering with Bax activation. *J Biol Chem* *279*, 21233-21238.
- Harada, H., Quearry, B., Ruiz-Vela, A., and Korsmeyer, S.J. (2004). Survival factor-induced extracellular signal-regulated kinase phosphorylates BIM, inhibiting its association with BAX and proapoptotic activity. *Proc Natl Acad Sci USA* *101*, 15313-15317.
- Haraguchi, M., Torii, S., Matsuzawa, S.-i., Xie, Z., Kitada, S., Krajewski, S., Yoshida, H., Mak, T.W., and Reed, J.C. (2000). Apoptotic protease activating factor 1 (Apaf-1)-independent cell death suppression by Bcl-2. *J Exp Med* *191*, 1709-1720.

- Harris, M.H., Vander Heiden, M.G., Kron, S.J., and Thompson, C.B. (2000). Role of oxidative phosphorylation in Bax toxicity. *Mol Cell Biol* 20, 3590-3596.
- Hengartner, M.O., Ellis, R.E., and Horvitz, H.R. (1992). *Caenorhabditis elegans* gene *ced-9* protects cells from programmed cell death. *Nature* 356, 494-499.
- Hiller, S., Garces, R.G., Malia, T.J., Orekhov, V.Y., Colombini, M., and Wagner, G. (2008). Solution structure of the integral human membrane protein VDAC-1 in detergent micelles. *Science* 321, 1206-1210.
- Hodge, T., and Colombini, M. (1997). Regulation of metabolite flux through voltage-gating of VDAC channels. *J Membr Biol* 157, 271-279.
- Horvitz, H.R. (2003). Worms, life, and death (Nobel Lecture). *ChemBioChem* 4, 697-711.
- Hsu, Y.T., Wolter, K.G., and Youle, R.J. (1997). Cytosol-to-membrane redistribution of Bax and Bcl-X(L) during apoptosis. *Proc Natl Acad Sci USA* 94, 3668-3672.
- Hsu, Y.T., and Youle, R.J. (1997). Nonionic detergent induced dimerization of members of the Bcl-2 family. *J Biol Chem* 272, 13829-13834.
- Hsu, Y.T., and Youle, R.J. (1998). Bax in murine thymus is a soluble monomeric protein that displays differential detergent-induced conformations. *J Biol Chem* 273, 10777-10783.
- Imaizumi, K., Tsuda, M., Imai, Y., Wanaka, A., Takagi, T., and Tohyama, M. (1997). Molecular cloning of a novel polypeptide, DP5, induced during programmed neuronal death. *J Biol Chem* 272, 18842-18848.
- Imaizumi, K., Benito, A., Kiryu-Seo, S., Gonzalez, V., Inohara, N., Leiberman, A.P., Kiyama, H., and Nunez, G. (2004). Critical role for DP5/Harakiri, a Bcl-2 homology domain 3-only Bcl-2 family member, in axotomy-induced neuronal cell death. *J Neurosci* 24, 3721-3725.
- Inohara, N., Ding, L., Chen, S., and Nunez, G. (1997). harakiri, a novel regulator of cell death, encodes a protein that activates apoptosis and interacts selectively with survival-promoting proteins Bcl-2 and Bcl-X(L). *EMBO J* 16, 1686-1694.
- Jeffers, J.R., Parganas, E., Lee, Y., Yang, C., Wang, J., Brennan, J., MacLean, K.H., Han, J., Chittenden, T., Ihle, J.N., *et al.* (2003). Puma is an essential mediator of p53-dependent and -independent apoptotic pathways. *Cancer Cell* 4, 321-328
- Jones, R.G., and Thompson, C.B. (2009). Tumor suppressors and cell metabolism: a recipe for cancer growth. *Genes Dev* 23, 537-548.



- Kelekar, A., and Thompson, C.B. (1998). Bcl-2-family proteins: the role of the BH3 domain in apoptosis. *Trends in Cell Biol* 8, 324-330.
- Kerr, J.F., Wyllie, A.H., and Currie, A.R. (1972). Apoptosis: a basic biological phenomenon with wide-ranging implications in tissue kinetics. *Br J Cancer* 26, 239–257.
- Kim, H., Rafiuddin-Shah, M., Tu, H.-C., Jeffers, J.R., Zambetti, G.P., Hsieh, J.J.D., and Cheng, E.H.Y. (2006). Hierarchical regulation of mitochondrion-dependent apoptosis by BCL-2 subfamilies. *Nat Cell Biol* 8, 1348-1358.
- Kim, H., Tu, H.-C., Ren, D., Takeuchi, O., Jeffers, J.R., Zambetti, G.P., Hsieh, J.J.D., and Cheng, E.H.Y. (2009). Stepwise activation of BAX and BAK by tBID, BIM, and PUMA initiates mitochondrial apoptosis. *Mol Cell* *In press*.
- Konopleva, M., Contractor, R., Tsao, T., Samudio, I., Ruvolo, P.P., Kitada, S., Deng, X., Zhai, D., Shi, Y.-X., Sneed, T., *et al.* (2006). Mechanisms of apoptosis sensitivity and resistance to the BH3 mimetic ABT-737 in acute myeloid leukemia. *Cancer Cell* 10, 375-388.
- Korsmeyer, S.J., Wei, M.C., Saito, M., Weiler, S., Oh, K.J., and Schlesinger, P.H. (2000). Pro-apoptotic cascade activates BID, which oligomerizes BAK or BAX into pores that result in the release of cytochrome *c*. *Cell Death Differ* 7, 1166-1173.
- Kuwana, T., Mackey, M.R., Perkins, G., Ellisman, M.H., Latterich, M., Schneider, R., Green, D.R., and Newmeyer, D.D. (2002). Bid, Bax, and lipids cooperate to form supramolecular openings in the outer mitochondrial membrane. *Cell* 111, 331-342.
- Kuwana, T., Bouchier-Hayes, L., Chipuk, J.E., Bonzon, C., Sullivan, B.A., Green, D.R., and Newmeyer, D.D. (2005). BH3 domains of BH3-only proteins differentially regulate Bax-mediated mitochondrial membrane permeabilization both directly and indirectly. *Mol Cell* 17, 525-535.
- L. O'Connor, A.S., L.A. O'Reilly, G. Hausmann, J.M. Adams, S. Cory and D.C.S. Huang (1998). Bim: A novel member of the Bcl-2 family that promotes apoptosis. *EMBO J* 17, 384-395.
- Lalier, L., Cartron, P.-F., Juin, P., Nedelkina, S., Manon, S., Bechinger, B., and Vallette, F. (2007). Bax activation and mitochondrial insertion during apoptosis. *Apoptosis* 12, 887-896.
- Leber, B., Lin, J., and Andrews, D. (2007). Embedded together: The life and death consequences of interaction of the Bcl-2 family with membranes. *Apoptosis* 12, 897-911.
- Letai, A., Bassik, M.C., Walensky, L.D., Sorcinelli, M.D., Weiler, S., and Korsmeyer, S.J. (2002). Distinct BH3 domains either sensitize or activate mitochondrial apoptosis, serving as prototype cancer therapeutics. *Cancer Cell* 2, 183-192.

- Ley, R., Ewings, K.E., Hadfield, K., and Cook, S.J. (2005). Regulatory phosphorylation of Bim: sorting out the ERK from the JNK. *Cell Death Differ* 12, 1008-1014.
- Li, C., Fox, C.J., Master, S.R., Bindokas, V.P., Chodosh, L.A., and Thompson, C.B. (2002). Bcl-X<sub>L</sub> affects Ca<sup>2+</sup> homeostasis by altering expression of inositol 1,4,5-trisphosphate receptors. *Proc Natl Acad Sci USA* 99, 9830-9835.
- Li, H., Zhu, H., Xu, C.J., and Yuan, J. (1998). Cleavage of BID by caspase 8 mediates the mitochondrial damage in the Fas pathway of apoptosis. *Cell* 94, 491-501.
- Li, L.Y., Luo, X., and Wang, X. (2001). Endonuclease G is an apoptotic DNase when released from mitochondria. *Nature* 412, 95-99.
- Lin, X., Morgan-Lappe, S., Huang, X., Li, L., Zakula, D.M., Verneti, L.A., Fesik, S.W., and Shen, Y. (2006). 'Seed' analysis of off-target siRNAs reveals an essential role of Mcl-1 in resistance to the small-molecule Bcl-2/Bcl-XL inhibitor ABT-737. *Oncogene* 26, 3972-3979.
- Lindsten, T., Ross, A.J., King, A., Zong, W.-X., Rathmell, J.C., Shiels, H.A., Ulrich, E., Waymire, K.G., Mahar, P., Frauwirth, K., *et al.* (2000). The combined functions of proapoptotic Bcl-2 family members Bak and Bax are essential for normal development of multiple tissues. *Mol Cell* 6, 1389-1399.
- Liu, X., Dai, S., Zhu, Y., Marrack, P., and Kappler, J.W. (2003). The structure of a Bcl-xL/Bim fragment complex: implications for Bim function. *Immunity* 19, 341-352.
- Lovell, J.F., Billen, L.P., Bindner, S., Shamas-Din, A., Fradin, C., Leber, B., and Andrews, D.W. (2008). Membrane binding by tBid initiates an ordered series of events culminating in membrane permeabilization by Bax. *Cell* 135, 1074-1084.
- Lucken-Ardjomande, S., Montessuit, S., and Martinou, J.C. (2008a). Bax activation and stress-induced apoptosis delayed by the accumulation of cholesterol in mitochondrial membranes. *Cell Death Differ* 15, 484-493.
- Lucken-Ardjomande, S., Montessuit, S., and Martinou, J.C. (2008b). Contributions to Bax insertion and oligomerization of lipids of the mitochondrial outer membrane. *Cell Death Differ* 15, 929-937.
- Luo, X., Budihardjo, I., Zou, H., Slaughter, C., and Wang, X. (1998). Bid, a Bcl2 interacting protein, mediates cytochrome *c* release from mitochondria in response to activation of cell surface death receptors. *Cell* 94, 481-490.
- Makin, G.W.J., Corfe, B. M., Griffiths, G. J., Thistlethwaite, A., Hickman, J. A., and Dive, C. (2001). Damage-induced Bax N-terminal change, translocation to mitochondria

and formation of Bax dimers/complexes occur regardless of cell fate. *EMBO J* 20, 6306-6315.

Mao, Y.W., Liu, J.P., Xiang, H., and Li, D.W.C. (2004). Human  $\alpha$ A- and  $\alpha$ B-crystallins bind to Bax and Bcl-X<sub>S</sub> to sequester their translocation during staurosporine-induced apoptosis. *Cell Death Differ* 11, 512-526.

Marani, M., Tenev, T., Hancock, D., Downward, J., and Lemoine, N.R. (2002). Identification of novel isoforms of the BH3 domain protein Bim which directly activate Bax to trigger apoptosis. *Mol Cell Biol* 22, 3577-3589.

Martinez-Caballero, S., Dejean, L.M., Kinnally, M.S., Oh, K.J., Mannella, C.A., and Kinnally, K.W. (2009). Assembly of the mitochondrial apoptosis-induced channel, MAC. *J Biol Chem* 284, 12235-12245.

Mason, K.D., Carpinelli, M.R., Fletcher, J.I., Collinge, J.E., Hilton, A.A., Ellis, S., Kelly, P.N., Ekert, P.G., Metcalf, D., Roberts, A.W., *et al.* (2007). Programmed anuclear cell death delimits platelet life span. *Cell* 128, 1173-1186.

Matsuyama, S., Xu, Q., Velours, J., and Reed, J.C. (1998). The mitochondrial F<sub>0</sub>F<sub>1</sub>-ATPase proton pump is required for function of the proapoptotic protein Bax in yeast and mammalian cells. *Mol Cell* 1, 327-336.

McDonnell, J.M., Fushman, D., Milliman, C.L., Korsmeyer, S.J., and Cowburn, D. (1999). Solution structure of the proapoptotic molecule BID: A structural basis for apoptotic agonists and antagonists. *Cell* 96, 625-634.

McDonnell, T.J., Deane, N., Platt, F.M., Nunez, G., Jaeger, U., McKearn, J.P., and Korsmeyer, S.J. (1989). bcl-2-Immunoglobulin transgenic mice demonstrate extended B cell survival and follicular lymphoproliferation. *Cell* 57, 79-88.

McEnery, M.W., Snowman, A.M., Trifiletti, R.R., and Snyder, S.H. (1992). Isolation of the mitochondrial benzodiazepine receptor: association with the voltage-dependent anion channel and the adenine nucleotide carrier. *Proc Natl Acad Sci USA* 89, 3170-3174.

Mihara, M., Erster, S., Zaika, A., Petrenko, O., Chittenden, T., Pancoska, P., and Moll, U.M. (2003). p53 has a direct apoptogenic role at the mitochondria. *Mol Cell* 11, 577-590.

Mitchell, A. (2001). Bax to Bak. *Nat Rev Mol Cell Biol* 2, 6-6.

Moldoveanu, T., Liu, Q., Tocilj, A., Watson, M., Shore, G., and Gehring, K. (2006). The X-Ray structure of a BAK homodimer reveals an inhibitory Zinc binding site. *Mol Cell* 24, 677-688.

Mootha, V.K., Wei, M.C., Buttle, K.F., Scorrano, L., Panoutsakopoulou, V., Mannella, C.A., and Korsmeyer, S.J. (2001). A reversible component of mitochondrial respiratory

dysfunction in apoptosis can be rescued by exogenous cytochrome *c*. *EMBO J* 20, 661-671.

Morrison, D.J., English, M.A., and Licht, J.D. (2005). WT1 induces apoptosis through transcriptional regulation of the proapoptotic Bcl-2 family member Bak. *Cancer Res* 65, 8174-8182.

Motoyama, N., Wang, F., Roth, K., Sawa, H., Nakayama, K., Negishi, I., Senju, S., Zhang, Q., Fujii, S., and et, a. (1995). Massive cell death of immature hematopoietic cells and neurons in Bcl-x-deficient mice. *Science* 267, 1506-1510.

Nakagawa, T., Shimizu, S., Watanabe, T., Yamaguchi, O., Otsu, K., Yamagata, H., Inohara, H., Kubo, T., and Tsujimoto, Y. (2005). Cyclophilin D-dependent mitochondrial permeability transition regulates some necrotic but not apoptotic cell death. *Nature* 434, 652-658.

Nakano, K., and Vousden, K.H. (2001). PUMA, a novel proapoptotic gene, is induced by p53. *Mol Cell* 7, 683-694.

Nam, Y.-J., Mani, K., Ashton, A.W., Peng, C.-F., Krishnamurthy, B., Hayakawa, Y., Lee, P., Korsmeyer, S.J., and Kitsis, R.N. (2004). Inhibition of both the extrinsic and intrinsic death pathways through nonhomotypic death-fold interactions. *Mol Cell* 15, 901-912.

Nechushtan, A., Smith, C.L., Hsu, Y.T., and Youle, R.J. (1999). Conformation of the Bax C-terminus regulates subcellular location and cell death. *EMBO J* 18, 2330-2341.

Newmeyer, D.D., and Ferguson-Miller, S. (2003). Mitochondria: releasing power for life and unleashing the machineries of death. *Cell* 112, 481-490.

Nguyen, M., Millar, D.G., Yong, V.W., Korsmeyer, S.J., and Shore, G.C. (1993). Targeting of Bcl-2 to the mitochondrial outer membrane by a COOH-terminal signal anchor sequence. *J Biol Chem* 268, 25265-25268.

Nijhawan, D., Fang, M., Traer, E., Zhong, Q., Gao, W., Du, F., and Wang, X. (2003). Elimination of Mcl-1 is required for the initiation of apoptosis following ultraviolet irradiation. *Genes Dev* 17, 1475-1486.

Nomura, M., Shimizu, S., Sugiyama, T., Narita, M., Ito, T., Matsuda, H., and Tsujimoto, Y. (2003). 14-3-3 Interacts Directly with and Negatively Regulates Pro-apoptotic Bax. *J Biol Chem* 278, 2058-2065.

Nouraini, S., Six, E., Matsuyama, S., Krajewski, S., and Reed, J.C. (2000). The putative pore-forming domain of Bax regulates mitochondrial localization and interaction with Bcl-X<sub>L</sub>. *Mol Cell Biol* 20, 1604-1615.

- Oakes, S.A., Scorrano, L., Opferman, J.T., Bassik, M.C., Nishino, M., Pozzan, T., and Korsmeyer, S.J. (2005). Proapoptotic BAX and BAK regulate the type 1 inositol trisphosphate receptor and calcium leak from the endoplasmic reticulum. *Proc Natl Acad Sci USA* *102*, 105-110.
- Oda, E., Ohki, R., Murasawa, H., Nemoto, J., Shibue, T., Yamashita, T., Tokino, T., Taniguchi, T., and Tanaka, N. (2000). Noxa, a BH3-only member of the Bcl-2 family and candidate mediator of p53-induced apoptosis. *Science* *288*, 1053-1058.
- Oltersdorf, T., Elmore, S.W., Shoemaker, A.R., Armstrong, R.C., Augeri, D.J., Belli, B.A., Bruncko, M., Deckwerth, T.L., Dinges, J., Hajduk, P.J., *et al.* (2005). An inhibitor of Bcl-2 family proteins induces regression of solid tumours. *Nature* *435*, 677-681.
- Opferman, J.T., Letai, A., Beard, C., Sorcinelli, M.D., Ong, C.C., and Korsmeyer, S.J. (2003). Development and maintenance of B and T lymphocytes requires antiapoptotic MCL-1. *Nature* *426*, 671-676.
- Opferman, J.T., Iwasaki, H., Ong, C.C., Suh, H., Mizuno, S.-i., Akashi, K., and Korsmeyer, S.J. (2005). Obligate role of anti-apoptotic MCL-1 in the survival of hematopoietic stem cells. *Science* *307*, 1101-1104.
- Pastorino, J.G., Chen, S.-T., Tafani, M., Snyder, J.W., and Farber, J.L. (1998). The overexpression of Bax produces cell death upon induction of the mitochondrial permeability transition. *J Biol Chem* *273*, 7770-7775.
- Pavlov, E.V., Priault, M., Pietkiewicz, D., Cheng, E.H.-Y., Antonsson, B., Manon, S., Korsmeyer, S.J., Mannella, C.A., and Kinnally, K.W. (2001). A novel, high conductance channel of mitochondria linked to apoptosis in mammalian cells and Bax expression in yeast. *J Cell Biol* *155*, 725-732.
- Pedersen, P. (2007). Warburg, me and Hexokinase 2: Multiple discoveries of key molecular events underlying one of cancers' most common phenotypes, the "Warburg Effect", i.e., elevated glycolysis in the presence of oxygen. *J Bioenerg Biomembr* *39*, 211-222.
- Petros, A.M., Nettesheim, D.G., Wang, Y., Olejniczak, E.T., Meadows, R.P., Mack, J., Swift, K., Matayoshi, E.D., Zhang, H., Fesik, S.W., *et al.* (2000). Rationale for Bcl-X<sub>L</sub>/Bad peptide complex formation from structure, mutagenesis, and biophysical studies. *Protein Sci* *9*, 2528-2534.
- Peyerl, F.W. (2006). Elucidation of some Bax conformational changes through crystallization of an antibody-peptide complex. *Cell Death Differ* *14*, 447-452.
- Putcha, G.V., Moulder, K.L., Golden, J.P., Bouillet, P., Adams, J.A., Strasser, A., and Johnson, E.M. (2001). Induction of BIM, a proapoptotic BH3-only BCL-2 family member, is critical for neuronal apoptosis. *Neuron* *29*, 615-628.

- Puthalakath, H., Huang, D.C., O'Reilly, L.A., King, S.M., and Strasser, A. (1999). The proapoptotic activity of the Bcl-2 family member Bim is regulated by interaction with the dynein motor complex. *Mol Cell* 3, 287-296.
- Puthalakath, H., Villunger, A., O'Reilly, L.A., Beaumont, J.G., Coultas, L., Cheney, R.E., Huang, D.C.S., and Strasser, A. (2001). Bmf: A Proapoptotic BH3-only protein regulated by interaction with the myosin V actin motor complex, activated by anoikis. *Science* 293, 1829-1832.
- Puthalakath, H., O'Reilly, L.A., Gunn, P., Lee, L., Kelly, P.N., Huntington, N.D., Hughes, P.D., Michalak, E.M., McKimm-Breschkin, J., Motoyama, N., *et al.* (2007). ER stress triggers apoptosis by activating BH3-only protein Bim. *Cell* 129, 1337-1349.
- Ranger, A.M., Zha, J., Harada, H., Datta, S.R., Danial, N.N., Gilmore, A.P., Kutok, J.L., Le Beau, M.M., Greenberg, M.E., and Korsmeyer, S.J. (2003). Bad-deficient mice develop diffuse large B cell lymphoma. *Proc Natl Acad Sci USA* 100, 9324-9329.
- Rathmell, J.C., Fox, C.J., Plas, D.R., Hammerman, P.S., Cinalli, R.M., and Thompson, C.B. (2003). Akt-directed glucose metabolism can prevent Bax conformation change and promote growth factor-independent survival. *Mol Cell Biol* 23, 7315-7328.
- Reed, J.C. (2006). Proapoptotic multidomain Bcl-2/Bax-family proteins: mechanisms, physiological roles, and therapeutic opportunities. *Cell Death Differ* 13, 1378-1386.
- Ren, D., Kim, H., Tu, H.-C., Westergard, T.D., Fisher, J.K., Rubens, J.A., Korsmeyer, S.J., Hsieh, J.J.-D., and Cheng, E.H.-Y. (2009). The VDAC2-BAK rheostat controls thymocyte survival. *Sci Signal* 2, ra48.
- Rinkenberger, J.L., Horning, S., Klocke, B., Roth, K., and Korsmeyer, S.J. (2000). Mcl-1 deficiency results in peri-implantation embryonic lethality. *Genes Dev* 14, 23-27.
- Robey, R.B., and Hay, N. (2006). Mitochondrial hexokinases, novel mediators of the antiapoptotic effects of growth factors and Akt. *Oncogene* 25, 4683-4696.
- Rostovtseva, T.K., Antonsson, B., Suzuki, M., Youle, R.J., Colombini, M., and Bezrukov, S.M. (2004). Bid, but not Bax, regulates VDAC channels. *J Biol Chem* 279, 13575-13583.
- Saito, M., Korsmeyer, S.J., and Schlesinger, P.H. (2000). BAX-dependent transport of cytochrome *c* reconstituted in pure liposomes. *Nat Cell Biol* 2, 553-555.
- Samuel, T., Weber, H.O., Rauch, P., Verdoodt, B., Eppel, J.-T., McShea, A., Hermeking, H., and Funk, J.O. (2001). The G<sub>2</sub>/M Regulator 14-3-3 $\sigma$  prevents apoptosis through sequestration of Bax. *J Biol Chem* 276, 45201-45206.

- Sattler, M., Liang, H., Nettesheim, D., Meadows, R.P., Harlan, J.E., Eberstadt, M., Yoon, H.S., Shuker, S.B., Chang, B.S., Minn, A.J., *et al.* (1997). Structure of Bcl-xL-Bak peptide complex: recognition between regulators of apoptosis. *Science* 275, 983-986.
- Sawada, M., Sun, W., Hayes, P., Leskov, K., Boothman, D.A., and Matsuyama, S. (2003). Ku70 suppresses the apoptotic translocation of Bax to mitochondria. *Nat Cell Biol* 5, 320-329.
- Schafer, B., Quispe, J., Choudhary, V., Chipuk, J.E., Ajero, T.G., Du, H., Schneider, R., and Kuwana, T. (2009). Mitochondrial outer membrane proteins assist Bid in Bax-mediated lipidic pore formation. *Mol Biol Cell* 20, 2276-2285.
- Schinzel, A., Kaufmann, T., Schuler, M., Martinalbo, J., Grubb, D., and Borner, C. (2004). Conformational control of Bax localization and apoptotic activity by Pro168. *J Cell Biol* 164, 1021-1032.
- Scorrano, L., Oakes, S.A., Opferman, J.T., Cheng, E.H., Sorcinelli, M.D., Pozzan, T., and Korsmeyer, S.J. (2003). BAX and BAK regulation of endoplasmic reticulum  $Ca^{2+}$ : a control point for apoptosis. *Science* 300, 135-139.
- Shi, Y. (2006). Mechanical aspects of apoptosome assembly. *Curr Opin Cell Biol* 18, 677-684.
- Shibue, T., Takeda, K., Oda, E., Tanaka, H., Murasawa, H., Takaoka, A., Morishita, Y., Akira, S., Taniguchi, T., and Tanaka, N. (2003). Integral role of Noxa in p53-mediated apoptotic response. *Genes Dev* 17, 2233-2238.
- Shirane, M., and Nakayama, K.I. (2003). Inherent calcineurin inhibitor FKBP38 targets Bcl-2 to mitochondria and inhibits apoptosis. *Nat Cell Biol* 5, 28-37.
- Simamura, E., Hirai, K.-I., Shimada, H., Pan, J., and Koyama, J. (2003). Mitochondrial damage prior to apoptosis in furanonaphthoquinone treated lung cancer cells. *Cancer Detect Prev* 27, 5-13.
- Simamura, E., Hirai, K., Shimada, H., Koyama, J., Niwa, Y., and Shimizu, S. (2006). Furanonaphthoquinones cause apoptosis of cancer cells by inducing the production of reactive oxygen species by the mitochondrial voltage-dependent anion channel. *Cancer Biol Ther* 5, 1523-1529.
- Simonen, M., Keller, H., and Heim, J. (1997). The BH3 domain of Bax is sufficient for interaction of Bax with itself and with other family members and it is required for induction of apoptosis. *Eur J Biochem* 249, 85-91.
- Susin, S.A., Lorenzo, H.K., Zamzami, N., Marzo, I., Snow, B.E., Brothers, G.M., Mangion, J., Jacotot, E., Costantini, P., Loeffler, M., *et al.* (1999). Molecular characterization of mitochondrial apoptosis-inducing factor. *Nature* 397, 441-446.

- Suzuki, M., Youle, R.J., and Tjandra, N. (2000). Structure of Bax: coregulation of dimer formation and intracellular localization. *Cell* *103*, 645-654.
- Terradillos, O., Montessuit, S., Huang, D.C., and Martinou, J.C. (2002). Direct addition of BimL to mitochondria does not lead to cytochrome *c* release. *FEBS Lett* *522*, 29-34.
- Terrones, O., Antonsson, B., Yamaguchi, H., Wang, H.-G., Liu, J., Lee, R.M., Herrmann, A., and Basanez, G. (2004). Lipidic pore formation by the concerted action of proapoptotic BAX and tBID. *J Biol Chem* *279*, 30081-30091.
- Thompson, C.B. (1995). Apoptosis in the pathogenesis and treatment of disease. *Science* *267*, 1456-1462.
- Thornberry, N.A., and Lazebnik, Y. (1998). Caspases: enemies within. *Science* *281*, 1312-1316.
- Tsujimoto, Y., Cossman, J., Jaffe, E., and Croce, C.M. (1985). Involvement of the *bcl-2* gene in human follicular lymphoma. *Science* *228*, 1440-1443.
- Ujwal, R., Cascio, D., Colletier, J.-P., Faham, S., Zhang, J., Toro, L., Ping, P., and Abramson, J. (2008). The crystal structure of mouse VDAC1 at 2.3 Å resolution reveals mechanistic insights into metabolite gating. *Proc Natl Acad Sci USA* *105*, 17742-17747.
- Upton, J.-P., Austgen, K., Nishino, M., Coakley, K.M., Hagen, A., Han, D., Papa, F.R., and Oakes, S.A. (2008). Caspase-2 cleavage of BID is a critical apoptotic signal downstream of endoplasmic reticulum stress. *Mol Cell Biol* *28*, 3943-3951.
- Van Delft, M.F., Wei, A.H., Mason, K.D., Vandenberg, C.J., Chen, L., Czabotar, P.E., Willis, S.N., Scott, C.L., Day, C.L., Cory, S., *et al.* (2006). The BH3 mimetic ABT-737 targets selective Bcl-2 proteins and efficiently induces apoptosis via Bak/Bax if Mcl-1 is neutralized. *Cancer Cell* *10*, 389-399.
- Van Loo, G., Van Gurp, M., Depuydt, B., Srinivasula, S.M., Rodriguez, I., Alnemri, E.S., Gevaert, K., Vandekerckhove, J., Declercq, W., and Vandennebeele, P. (2001). The serine protease Omi/HtrA2 is released from mitochondria during apoptosis. Omi interacts with caspase-inhibitor XIAP and induces enhanced caspase activity. *Cell Death Differ* *9*, 20-26.
- Vander Heiden, M.G., Chandel, N.S., Williamson, E.K., Schumacker, P.T., and Thompson, C.B. (1997). Bcl-xL regulates the membrane potential and volume homeostasis of mitochondria. *Cell* *91*, 627-637.
- Vander Heiden, M.G., and Thompson, C.B. (1999). Bcl-2 proteins: regulators of apoptosis or of mitochondrial homeostasis? *Nat Cell Biol* *1*, E209-E216.



- Vander Heiden, M.G., Chandel, N.S., Schumacker, P.T., and Thompson, C.B. (1999). Bcl-xL prevents cell death following growth factor withdrawal by facilitating mitochondrial ATP/ADP exchange. *Mol Cell* 3, 159-167.
- Vander Heiden, M.G., Chandel, N.S., Li, X.X., Schumacker, P.T., Colombini, M., and Thompson, C.B. (2000). Outer mitochondrial membrane permeability can regulate coupled respiration and cell survival. *Proc Natl Acad Sci USA* 97, 4666-4671.
- Vander Heiden, M.G., Li, X.X., Gottleib, E., Hill, R.B., Thompson, C.B., and Colombini, M. (2001). Bcl-xL promotes the open configuration of the voltage-dependent anion channel and metabolite passage through the outer mitochondrial membrane. *J Biol Chem* 276, 19414-19419.
- Vaux, D.L., Cory, S., and Adams, J.M. (1988). Bcl-2 gene promotes hematopoietic cell survival and cooperates with *c-myc* to immortalize pre-B-cells. *Nature* 335, 440-442.
- Veis, D.J., Sorenson, C.M., Shutter, J.R., and Korsmeyer, S.J. (1993). Bcl-2-deficient mice demonstrate fulminant lymphoid apoptosis, polycystic kidneys, and hypopigmented hair. *Cell* 75, 229-240.
- Verhagen, A.M., Ekert, P.G., Pakusch, M., Silke, J., Connolly, L.M., Reid, G.E., Moritz, R.L., Simpson, R.J., and Vaux, D.L. (2000). Identification of DIABLO, a mammalian protein that promotes apoptosis by binding to and antagonizing IAP Proteins. *Cell* 102, 43-53.
- Villunger, A., Michalak, E.M., Coultas, L., Mullauer, F., Bock, G., Ausserlechner, M.J., Adams, J.M., and Strasser, A. (2003). p53- and drug-induced apoptotic responses mediated by BH3-only proteins Puma and Noxa. *Science* 302, 1036-1038.
- Walensky, L.D., Kung, A.L., Escher, I., Malia, T.J., Barbuto, S., Wright, R.D., Wagner, G., Verdine, G.L., and Korsmeyer, S.J. (2004). Activation of apoptosis *in vivo* by a hydrocarbon-stapled BH3 helix. *Science* 305, 1466-1470.
- Walensky, L.D. (2006). BCL-2 in the crosshairs: tipping the balance of life and death. *Cell Death Differ* 13, 1339-1350.
- Walensky, L.D., Pitter, K., Morash, J., Oh, K.J., Barbuto, S., Fisher, J., Smith, E., Verdine, G.L., and Korsmeyer, S.J. (2006). A stapled BID BH3 helix directly binds and activates BAX. *Mol Cell* 24, 199-210.
- Wallace, D.C., and Fan, W. (2009). The pathophysiology of mitochondrial disease as modeled in the mouse. *Genes Dev* 23, 1714-1736.
- Wang, G., Nikolovska-Coleska, Z., Yang, C.-Y., Wang, R., Tang, G., Guo, J., Shangary, S., Qiu, S., Gao, W., Yang, D., *et al.* (2006). Structure-based design of potent small-molecule inhibitors of anti-apoptotic Bcl-2 proteins. *J Med Chem* 49, 6139-6142.

- Wang, K., Yin, X.M., Chao, D.T., Milliman, C.L., and Korsmeyer, S.J. (1996). BID: a novel BH3 domain-only death agonist. *Genes Dev* *10*, 2859-2869.
- Wang, K., Gross, A., Waksman, G., and Korsmeyer, S.J. (1998). Mutagenesis of the BH3 domain of BAX identifies residues critical for dimerization and killing. *Mol Cell Biol* *18*, 6083-6089.
- Wang, X. (2001). The expanding role of mitochondria in apoptosis. *Genes Dev* *15*, 2922-2933.
- Wei, M.C., Lindsten, T., Mootha, V.K., Weiler, S., Gross, A., Ashiya, M., Thompson, C.B., and Korsmeyer, S.J. (2000). tBID, a membrane-targeted death ligand, oligomerizes BAK to release cytochrome *c*. *Genes Dev* *14*, 2060-2071.
- Wei, M.C., Zong, W.-X., Cheng, E.H.-Y., Lindsten, T., Panoutsakopoulou, V., Ross, A.J., Roth, K.A., MacGregor, G.R., Thompson, C.B., and Korsmeyer, S.J. (2001). Proapoptotic BAX and BAK: a requisite gateway to mitochondrial dysfunction and death. *Science* *292*, 727-730.
- White, C., Li, C., Yang, J., Petrenko, N.B., Madesh, M., Thompson, C.B., and Foskett, J.K. (2005). The endoplasmic reticulum gateway to apoptosis by Bcl-X<sub>L</sub> modulation of the InsP3R. *Nat Cell Biol* *7*, 1021-1028.
- Whitfield, J., Neame, S.J., Paquet, L., Bernard, O., and Ham, J. (2001). Dominant-negative c-Jun promotes neuronal survival by reducing BIM expression and inhibiting mitochondrial cytochrome *c* release. *Neuron* *29*, 629-643.
- Willis, S.N., Chen, L., Dewson, G., Wei, A., Naik, E., Fletcher, J.I., Adams, J.M., and Huang, D.C.S. (2005). Proapoptotic Bak is sequestered by Mcl-1 and Bcl-xL, but not Bcl-2, until displaced by BH3-only proteins. *Genes Dev* *19*, 1294-1305.
- Willis, S.N., Fletcher, J.I., Kaufmann, T., van Delft, M.F., Chen, L., Czabotar, P.E., Ierino, H., Lee, E.F., Fairlie, W.D., Bouillet, P., *et al.* (2007). Apoptosis initiated when BH3 ligands engage multiple Bcl-2 homologs, not Bax or Bak. *Science* *315*, 856-859.
- Wolter, K.G., Hsu, Y.-T., Smith, C.L., Nechushtan, A., Xi, X.-G., and Youle, R.J. (1997). Movement of Bax from the cytosol to mitochondria during apoptosis. *J Cell Biol* *139*, 1281-1292.
- Wu, S., Sampson, M.J., Decker, W.K., and Craigen, W.J. (1999). Each mammalian mitochondrial outer membrane porin protein is dispensable: effects on cellular respiration. *Biochim Biophys Acta* *1452*, 68-78.

- Xiang, J., Chao, D.T., and Korsmeyer, S.J. (1996). BAX-induced cell death may not require interleukin 1 $\beta$ -converting enzyme-like proteases. *Proc Natl Acad Sci USA* *93*, 14559-14563.
- Yagoda, N., von Rechenberg, M., Zaganjor, E., Bauer, A.J., Yang, W.S., Fridman, D.J., Wolpaw, A.J., Smukste, I., Peltier, J.M., Boniface, J.J., *et al.* (2007). RAS-RAF-MEK-dependent oxidative cell death involving voltage-dependent anion channels. *Nature* *447*, 865-869.
- Yang, E., Zha, J., Jockel, J., Boise, L.H., Thompson, C.B., and Korsmeyer, S.J. (1995). Bad, a heterodimeric partner for Bcl-xL and Bcl-2, displaces Bax and promotes cell death. *Cell* *80*, 285-291.
- Yethon, J.A., Epand, R.F., Leber, B., Epand, R.M., and Andrews, D.W. (2003). Interaction with a membrane surface triggers a reversible conformational change in Bax normally associated with induction of apoptosis. *J Biol Chem* *278*, 48935-48941.
- Yin, X.-M., Wang, K., Gross, A., Zhao, Y., Zinkel, S., Klocke, B., Roth, K.A., and Korsmeyer, S.J. (1999). Bid-deficient mice are resistant to Fas-induced hepatocellular apoptosis. *Nature* *400*, 886-891.
- Yoshida, H., Kong, Y.-Y., Yoshida, R., Elia, A.J., Hakem, A., Hakem, R., Penninger, J.M., and Mak, T.W. (1998). Apaf-1 is required for mitochondrial pathways of apoptosis and brain development. *Cell* *94*, 739-750.
- Youle, R.J., and Strasser, A. (2008). The BCL-2 protein family: opposing activities that mediate cell death. *Nat Rev Mol Cell Biol* *9*, 47-59.
- Yu, J.Z., L. Hwang, P. M. Kinzler, K. W. Vogelstein, B. (2001). PUMA induces the rapid apoptosis of colorectal cancer cells. *Mol Cell* *7*, 673-682.
- Zha, J., Harada, H., Yang, E., Jockel, J., and Korsmeyer, S.J. (1996). Serine phosphorylation of death agonist BAD in response to survival factor results in binding to 14-3-3 not BCL-X<sub>L</sub>. *Cell* *87*, 619-628.
- Zha, J., Weiler, S., Oh, K.J., Wei, M.C., and Korsmeyer, S.J. (2000). Posttranslational N-myristoylation of BID as a molecular switch for targeting mitochondria and apoptosis. *Science* *290*, 1761-1765.
- Zhu, W.J., Cowie, A., Wasfy, G.W., Penn, L.Z., Leber, B., and Andrews, D.W. (1996). Bcl-2 mutants with restricted subcellular location reveal spatially distinct pathways for apoptosis in different cell types. *EMBO J* *15*, 4130-4141.
- Zong, W.-X., Lindsten, T., Ross, A.J., MacGregor, G.R., and Thompson, C.B. (2001). BH3-only proteins that bind pro-survival Bcl-2 family members fail to induce apoptosis in the absence of Bax and Bak. *Genes Dev* *15*, 1481-1486.

Zong, W.-X., Li, C., Hatzivassiliou, G., Lindsten, T., Yu, Q.-C., Yuan, J., and Thompson, C.B. (2003). Bax and Bak can localize to the endoplasmic reticulum to initiate apoptosis. *J Cell Biol* 162, 59-69.

## HYUNGJIN KIM

4525 Mcpherson Ave. #302  
St. Louis, MO, 63108  
Cell: (314) 537-0541, Work: (314) 362-1508  
[hkima@artsci.wustl.edu](mailto:hkima@artsci.wustl.edu)

---

---

### PERSONAL INFORMATION

Date of Birth: May 20<sup>th</sup>, 1979  
Nationality: Republic of Korea  
Program Affiliation: Molecular Cell Biology  
Lab Affiliation: Emily H.-Y. Cheng, M.D., Ph.D.

---

---

### EDUCATION

2004.8 – present  
Division of Biology and Biomedical Sciences, Washington University in St. Louis, U.S.A.  
Ph.D. in Molecular Cell Biology (Expected 2009.12)

1998.3 – 2004.2  
School of Biological Sciences, Seoul National University, South Korea  
Bachelor of Science, *summa cum laude* (GPA 3.98)

---

---

### RESEARCH EXPERIENCE

2005.3 – present                    **Washington University School of Medicine, St. Louis, USA**

Graduate researcher in Molecular Oncology/Department of Medicine  
Principal Investigator: Emily H.-Y. Cheng, M.D., Ph.D.  
Thesis: Regulation of BAX/BAK-dependent cell death program

2004.11 – 2005.3                    **Washington University School of Medicine, St. Louis, USA**

Graduate researcher in Molecular Oncology/Department of Medicine  
Principal Investigator: Jason D. Weber, Ph.D.  
Rotation project: Identification of the Nucleophosmin complex using proteomic approach

2004.8 – 2004.11                    **Washington University School of Medicine, St. Louis, USA**

Graduate researcher in Department of Pediatrics  
Principal Investigator: Guojun Bu, Ph.D.  
Rotation project: Contribution of LRP and apoE to intraneuronal A $\beta$  accumulation

2003.6 – 2004.6                    **Seoul National University, Seoul, South Korea**

Undergraduate researcher in Department of Biological Sciences  
Principal Investigator: Jeongbin Yim, Ph.D.  
Project: Role of target of wingless (tow) in planar cell polarity in *Drosophila* wing development

---

---

## TEACHING EXPERIENCE

2005.9 – 2005.12      **Washington University in St. Louis**

Course title: Principles of the Nervous System  
Performed teaching assistantship for the undergraduate biology course  
Wrote recommendation letters for students for medical school application

---

---

## PROFESSIONAL ACTIVITY

2000.11 -2002.10      **Eighth U.S. ARMY, Yongsan, South Korea**

Department of Radiology/Troops Medical Center  
Served as a radiology technician for sick-call patients and physical examinations

---

---

## PUBLICATIONS

**Kim H**, Tu HC, Ren D, Takeuchi O, Jeffers JR, Zambetti GP, Hsieh JJ-D, Cheng EH-Y. Stepwise activation of BAX and BAK by tBID, BIM, and PUMA initiates mitochondrial apoptosis. *Mol. Cell* 2009. *In press*

Ren D, **Kim H**, Tu HC, Westergard TD, Fisher JK, Rubens JA, Korsmeyer SJ, Hsieh JJ-D, Cheng EH-Y. The VDAC2-BAK rheostat controls thymocyte survival. *Sci. Signal.* 2009. 2:1-9

**Kim H**, Hsieh JJ-D, Cheng EH-Y. Deadly splicing: Bax becomes almighty. *Mol. Cell* 2009. 33:145-6

Tu HC, Ren D, Wang GX, Chen DY, Westergard TD, **Kim H**, Sasagawa S, Hsieh JJ-D, Cheng EH-Y. The p53-cathepsin axis cooperates with ROS to activate programmed necrotic death upon DNA damage. *Proc Natl Acad Sci U S A.* 2009. 106:1093-8

Gavathiotis E, Suzuki M, Davis ML, Pitter K, Bird GH, Katz SG, Tu HC, **Kim H**, Cheng EH-Y, Tjandra N, Walensky, LD. BAX activation is initiated at a novel interaction site. *Nature* 2008. 455: 1076-81

**Kim H**, Rafiuddin-Shah M, Tu HC, Jeffers JR, Zambetti GP, Hsieh JJ-D, Cheng EH-Y. Hierarchical regulation of mitochondrion-dependent apoptosis by BCL-2 subfamilies. *Nature Cell Biol.* 2006. 8:1348-58

Zerbinatti CV, Wahrle SE, **Kim H**, Cam JA, Bales K, Paul SM, Holtzman DM, Bu G. Apolipoprotein E and low density lipoprotein receptor-related protein facilitate intraneuronal A $\beta$ 42 accumulation in amyloid model mice. *J Biol Chem.* 2006. 281:36180-6

---

---

## HONORS & AWARDS

2005.9      **Washington University in St. Louis**  
Best Poster Award, Molecular Cell Biology Retreat

1998-2000, 2002-2004      **Seoul National University, South Korea**  
Academic Excellence Awards, full scholarship